



MODUTECH[®]

Movement Technologies

Modular Belt Product Brochure

www.modutech.com.tr

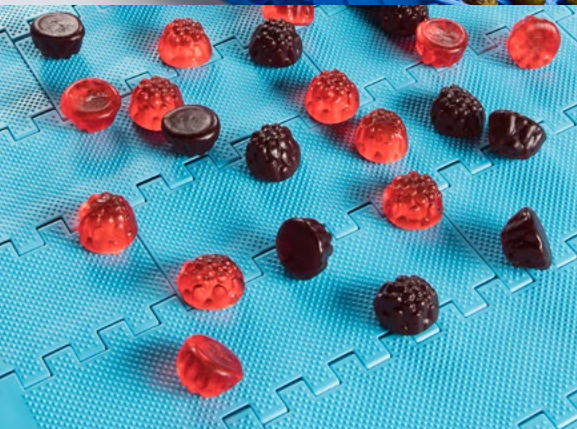

MODUTECH

Movement Technologies

We are rapidly growing. Thanks to the "understanding of excellence" in product and service quality, in the plastic modular belt sector. We export plastic modular belts and accessories (sprockets, flights, sidewalls) produced with high production standards to more than 40 countries, including 5 continents.

We have right partnerships with industrial companies, original equipment manufacturers and distributors in many countries of the world with the strength of our production quality, flexible capability, pre-sales and after-sales service.

We are constantly proving our expertise for food industry. We have FDA and EU approvals that are recognized as quality standards around the world for the safe and hygienic carry of food products.

With our movement technologies, we are carrying your business to the future.

Today and always.



Flexibility for various applications

Modular Belts are more durable, flexible and efficient than traditional conveyor belts because of their material and functional solutions.

Modutech Modular Belts are constructed of plastic modules. They are secured with full-length hinge rods and driven through plastic sprockets which allows customization with a variety of flights, side guards and accessories. In addition, with the advantages of resilience in difficult environments, sterilization, low maintenance and easy installation; modular belts offer high performance even in various applications.

Here are our applications for various industries:

- fruit and vegetable applications
- meat, poultry and seafood applications
- bakery and pasta applications
- beverage applications
- can applications
- corrugated applications



Modutech Modular Belts ensures quality

We rely on standardisation by producing plastic modular belts from design to plastic moulding and assembling at acceptable standards. With the high quality materials combined with ultimate engineering offers us specialization in the production of plastic modular belts. We ensure this quality through complying with FDA and EU regulations. These regulations provides precise manufacturing process and high performance conveyor belts.

High Quality Materials

Best material ensures superior product quality and performance. Because of the material quality, change in temperatures can be easily handled through operations. We offer you standard materials like PP, PE, POM (acetal) and special materials such as detectable, antistatic, flame retardant, extra high temperature, hot water resistant, reinforced and low friction.



Various Industries Need Special Solutions

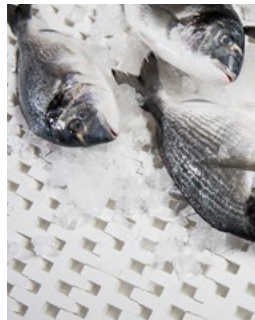

We offer combinable designs, materials and accessories for specific industries. Because, different working environments needs different solutions. Hygiene in case of bacteria retention is the key for food industry. Cleanliness standards are ensured through FDA and EU regulations. During manufacturing process, easy to clean and low maintenance helps you to keep these standards.



MODUTECH

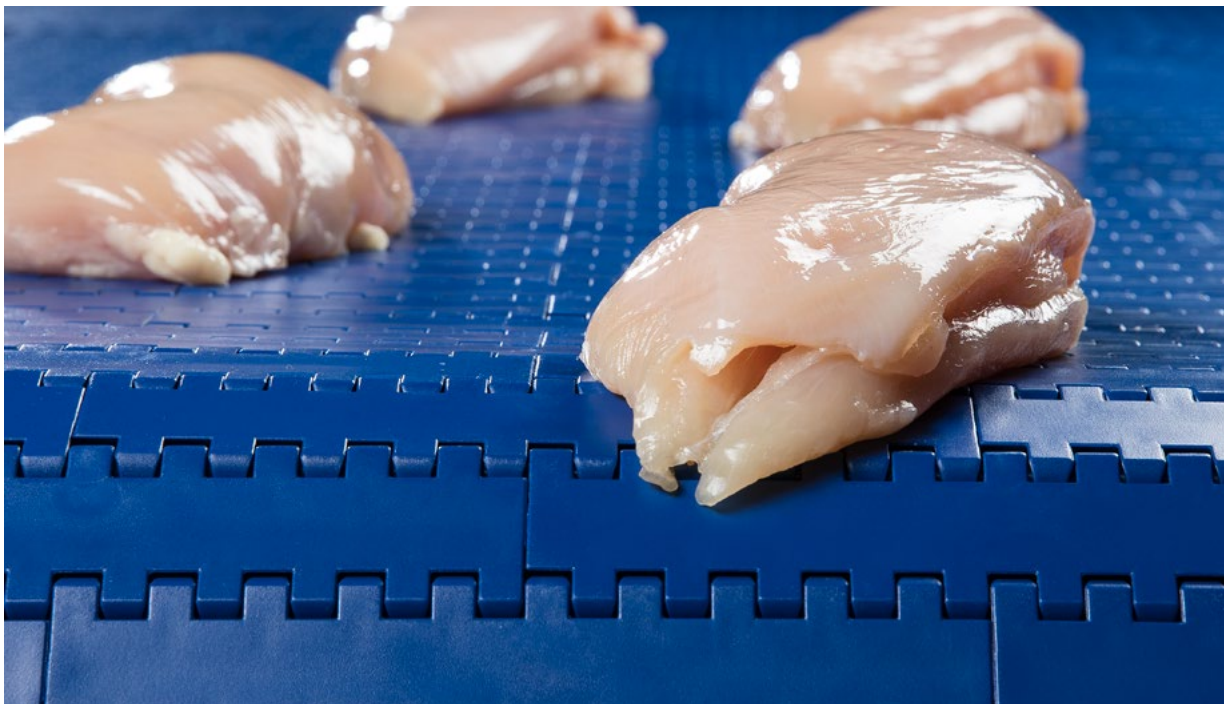

Customer satisfaction based qualified manufacturing



As Modutech Modular Belts, we see the customer satisfaction as one of the most crucial issues. To ensure the customer needs completely, our manufacturing plant which has a 5000 m² closed area and located in an industrial zone is working 7 days and 24 hours. We stock a wide variety of products so that we supply your urgent requests and demands. Delivery on time is also one of the most important matters for us. Through all of this hard work, we always aim to fulfil your requirements efficiently and thus to be your reliable business partner.



MODUTECH



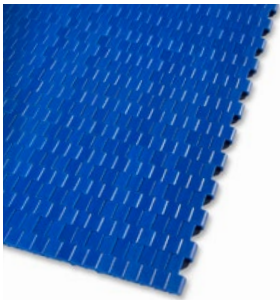

MP80 C
Micropitch Belt Series



MP80 FG
Micropitch Belt Series

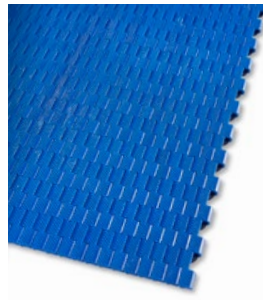

MP80 NS
Micropitch Belt Series

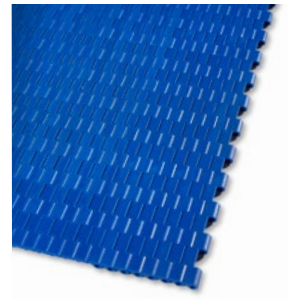

MP80 NP
Micropitch Belt Series



EC127 C

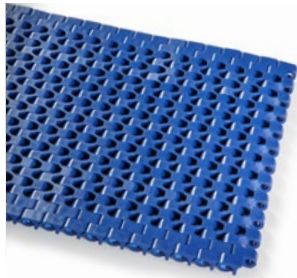

EC127 FG

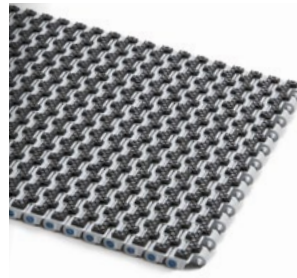

EC127 GT

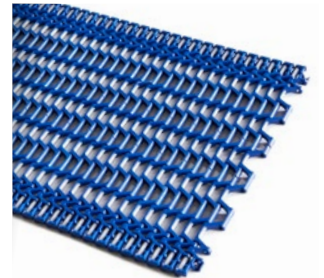

MD127 GAP%50

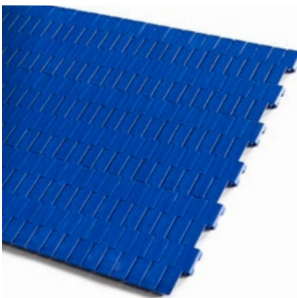

HC127 C



XP254 CR
Corrugated & Logistic Belt Series



XP254 FLT CR
Corrugated & Logistic Belt Series



XP254 C

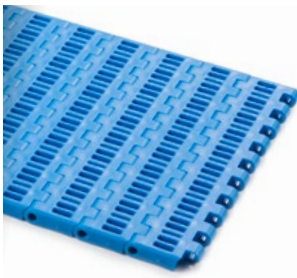

XP254 PR%22



XP254 FG

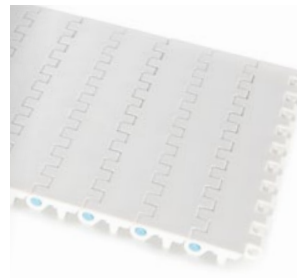

EC254 C



EC254 PR%16

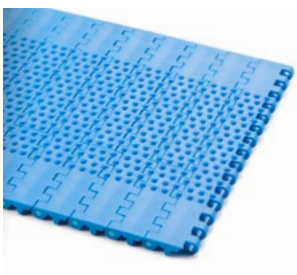

EC254 NT



MD254 FG



MD254 C

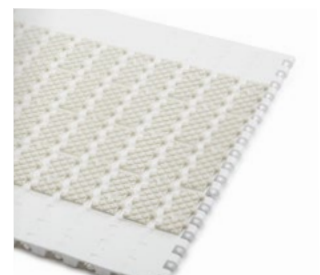

MD254 GT



MD254 RR



MD254 GAP%48



EC508 C



EC508 PR%22



EC508 FG

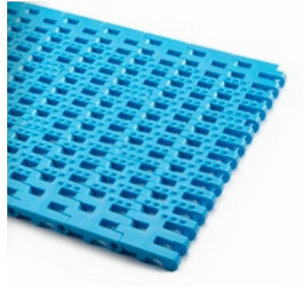

EC508 FG-NT



EC508 PR%11



EC508 PR%13

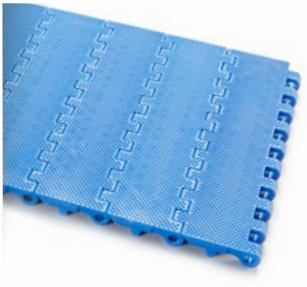

EC508 DT

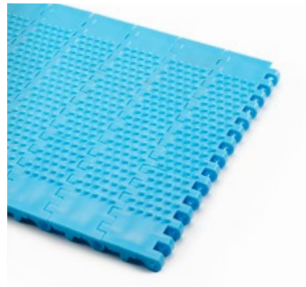

EC508 NT



MD508 C



MD508 FG



MD508 PR%25



HP508 RR



HP508 FG
Battery Belt



HP508 C

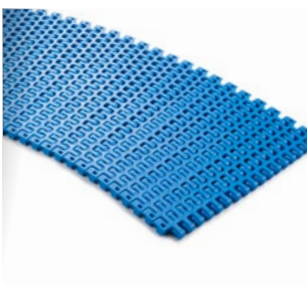

EC254 R
Radius Belt 2,1

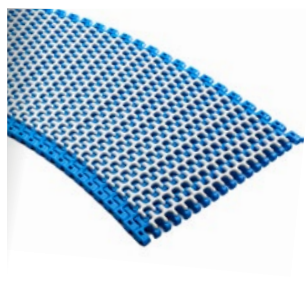

EC254 R-GT
Radius Belt 2,1 with friction surface



EC254T R
Tight Radius Belt 1,4



MODUTECH

MP80 C (Micropitch Series)

Pitch:	8 mm / 0.315 inch
Belt Surface:	Close, Smooth Surface
Minimum Width:	101,6 mm / 4 inch
Open Area (%):	0%
Flight:	No
Sidewall:	No
Rod:	Ø3 mm / 0.118 inch
Approved:	FDA and EU
Curve:	No
Color:	Additional colors available
Cleanability:	Good
Belt Thickness:	6 mm / 0.236 inch
Min. Nosebar Diameter:	6 mm / 0.236 inch

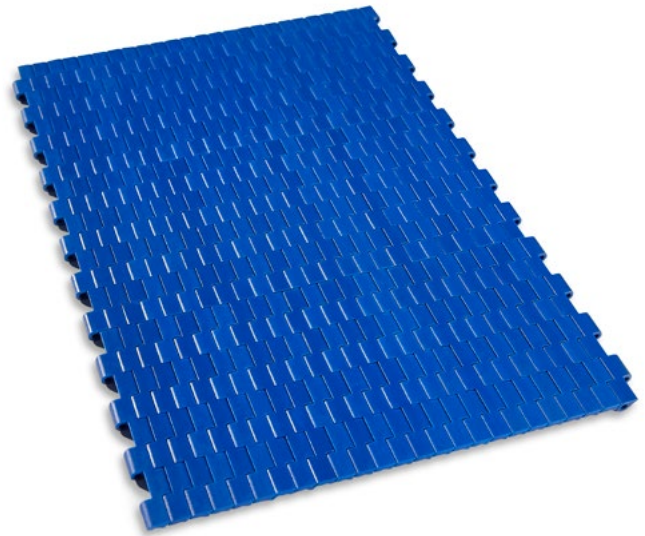

Product Features and Functional Benefits

- Micro pitch series with small transfer gaps for tight transfer.
- Designed to run over 6 mm nosebars or rollers.
- Belt and sprocket design ensures superior load transmission and belt pull capacity.
- Headless pin making it very easy to install and remove the belt for maintenance.

Available Moulded Module Sizes

- 203,2 mm / **8 inch** module
- 101,6 mm / **4 inch** module

MP80 C / Technical Information

BELT / PIN MATERIAL	BELT STRENGTH				TEMPERATURE		BELT WEIGHT
	Straight		Curve		°C / °F (min.)	°C / °F (max.)	Kg/m ² / lb/ft ²
	N/m	lb/ft	N/m	lb/ft			
Acetal / Acetal	2750	188	-	-	-43 / -45.4	+110 / +230	5,3 / 1.09

- Belt strength and temperature values are maximum on the table.

0,3 Inch - 8mm Micropitch Series

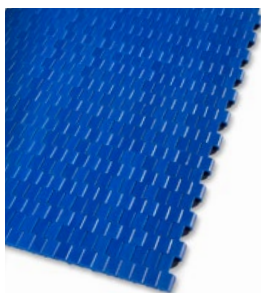

MP80 C
Micropitch Belt Series



MP80 FG
Micropitch Belt Series

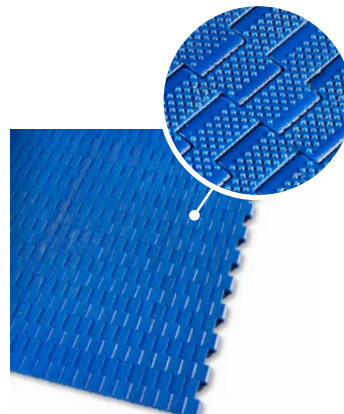

MP80 NS
Micropitch Belt Series
Non-slip Surface

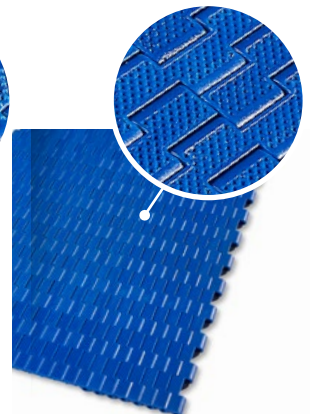

MP80 NP
Micropitch Belt Series
Negative Pyramid Surface



MODUTECH

MP80 (Micropitch Series)

Accessories and Technical Specifications

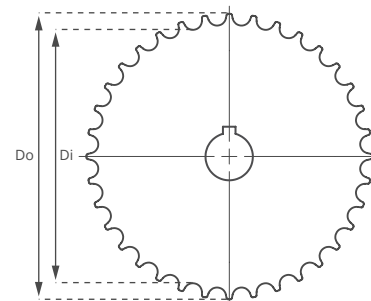
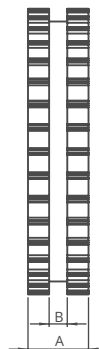
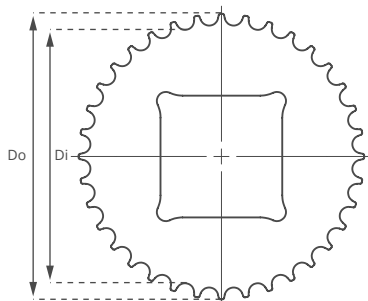

MP80 Micro Pitch Series / Machined Sprockets Dimensions

NO.TEETH	Di mm/inch	Do mm/inch	B mm/inch	A mm/inch	Square Bore (Q) mm/inch	Round Bore (R) mm/inch	PRODUCT CODE	
							Square Type (Q)	Round Type (R)
Z18	40,9 / 1.61	48,0 / 1.89	6 / 0.23	20 / 0.78	20 / 0.78	25 / 1	MP80SQZ18	MP80SRZ18
Z24	56,4 / 2.22	63,7 / 2.51	6 / 0.23	20 / 0.78	25 / 1	25-30 / 1-1.25	MP80SQZ24	MP80SRZ24
Z36	87,5 / 3.44	94,9 / 3.74	6 / 0.23	20 / 0.78	40 / 1.57	25-30 / 1-1.25	MP80SQZ36	MP80SRZ36

*All required sprockets produced by CNC.

*Other sprockets and hub sizes are manufactured up to request.

*POM (Acetal) and PA (Polyamide) sprockets raw material is available on request.

*Machined Split Sprockets are available for each size.



Tight Transfer

Precise transfer even the smallest products!

Micropitch belt series are suitable to run 6mm nosebar roller.





MODUTECH

EC127 C

Pitch:	12,7 mm / 0.5 inch
Belt Surface:	Close, Smooth Surface
Minimum Width:	50 mm / 1.97 inch
Open Area (%):	0%
Flight:	Yes (T25, T50)
Sidewall:	No
Rod:	Ø4,7 mm / 0.185 inch - Self Lock
Approved:	FDA and EU
Curve:	No
Color:	Additional colors available
Cleanability:	Good
Belt Thickness:	10 mm / 0.394 inch



Product Features and Functional Benefits

- Less vibration in high speed and nosebar applicaitons.
- Wear resistance in high speed applications with tight transfer.
- Unique sprocket engagement reduces pulsation.
- Tight transfer applications.
- Tight transfer and high speed conveyors.

Available Moulded Module Sizes

- 150 mm / **5.90 inch** module
- 100 mm / **3.94 inch** module
- 50 mm / **1.97 inch** module

EC127 C / Technical Information

BELT MATERIAL	BELT STRENGTH				TEMPERATURE		BELT WEIGHT
	Straight		Curve		°C / °F (min.)	°C/°F (max.)	Kg/m ² / lb/ft ²
	N/m	lb/ft	N/m	lb/ft			
Polypropylene	12100	829	-	-	+5 / +41	+90 / +194	5,8 / 1.20
Polyethylene	6600	452	-	-	-73 / -99.4	+66 / +150.8	6,2 / 1.27
Acetal	19800	1356	-	-	-43 / -45.4	+110 / +230	8,7 / 1.78

- Belt strength and temperature values are maximum on the table.

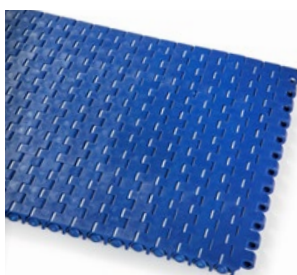

EC127 C

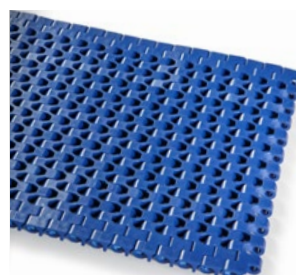

EC127 FG



EC127 GT

0,5 Inch - 12.7mm Modular Belt Series



EC127 Series *Accessories and Technical Specifications*



EC127 Series / Flight Dimensions

EC127 Series / Flights				
PRODUCT CODE	Flight Height (mm/ inch)	Flight Width (mm/ inch)	PRODUCT CODE	Sidewall Height (mm/ inch)
EC127T25	25 / 1	150 / 5.90	-	-
EC127T50	50 / 2	150 / 5.90	-	-

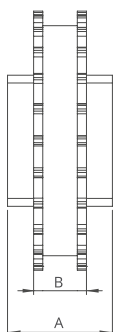
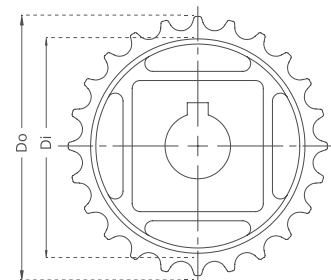
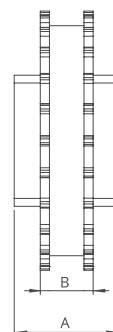
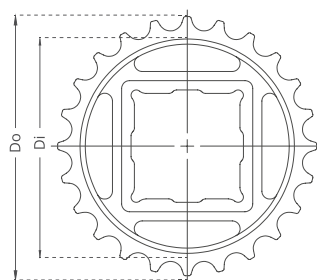

EC127 Series / Standard Moulded Sprockets Dimensions

NO.TEETH	Di mm/ inch	Do mm/ inch	B mm/ inch	A mm/ inch	Square Bore (Q) mm/ inch	Round Bore (R) mm/ inch	PRODUCT CODE	
							Square Type (Q)	Round Type (R)
Z19	68,5 / 2.69	78,0 / 2.54	20 / 0.79	40 / 1.57	25-40 / 1-1.5	25-30 / 1-1.25	EC127SQZ19*PA	EC127SRZ19*PA
Z24	88,7 / 3.49	98,8 / 3.89	20 / 0.79	40 / 1.57	25-40 / 1-1.5	25-30 / 1-1.25	EC127SQZ24*PA	EC127SRZ24*PA
Z28	105,0 / 4.13	115,2 / 4.53	20 / 0.79	40 / 1.57	25-40 / 1-1.5	25-30 / 1-1.25	EC127SQZ28*PA	EC127SRZ28*PA
Z30	113,0 / 4.44	123,3 / 4.85	20 / 0.79	40 / 1.57	25-40 / 1-1.5	25-30 / 1-1.25	EC127SQZ30*PA	EC127SRZ30*PA
Z36	137,5 / 5.41	148,0 / 5.82	20 / 0.79	40 / 1.57	25-40 / 1-1.5	25-30 / 1-1.25	EC127SQZ36*PA	EC127SRZ36*PA

*Other sprockets and hub sizes are manufactured up to request.

*POM (Acetal) and PP (Polypropylene) sprockets raw material is available on request.

***Machined Split Sprockets are available for each size.**

MD127 GAP%50

Pitch:	12,7 mm / 0.5 inch
Belt Surface:	Open, Smooth Surface
Minimum Width:	177,8 mm / 7 inch
Open Area (%):	50%. (Biggest opening 10 x 25 mm)
Flight:	No
Sidewall:	No
Rod:	Ø3,6 mm / 0.142 inch
Approved:	FDA and EU
Curve:	No
Color:	Additional colors available
Cleanability:	Excellent
Belt Thickness:	7 mm / 0.276 inch

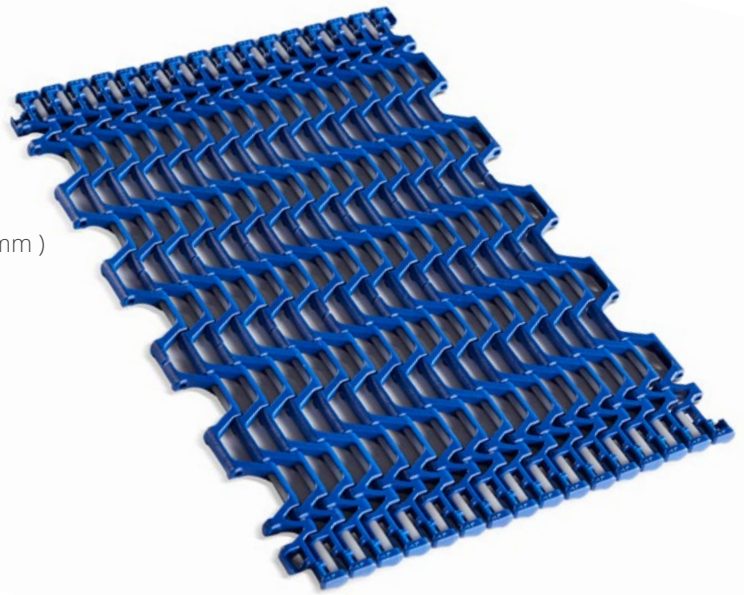

Product Features and Functional Benefits

- Belt provides optimal open area for drainage and airflow.
- Less friction and product contact for easy cooking, cooling and freezing of products.
- Reduced dirt and oxide build due to self cleaning surface.
- Easy to clean reduces downtime for cleaning time 80%.

Available Moulded Module Sizes

- 203,2 mm / **8 inch** module
- 177,8 mm / **7 inch** module
- 127 mm / **5 inch** module

MD127 GAP%50 / Technical Information

BELT MATERIAL	BELT STRENGTH				TEMPERATURE		BELT WEIGHT
	Straight		Curve		°C / °F (min.)	°C/°F (max.)	Kg/m ² / lb/ft ²
	N/m	lb/ft	N/m	lb/ft			
Polypropylene	3410	233	-	-	+5 / +41	+90 / +194	2,8 / 0.57
Polyethylene	-	-	-	-	-	-	-
Acetal	4840	331	-	-	-43 / -45.4	+110 / +230	3,6 / 0.75

- Belt strength and temperature values are maximum on the table.

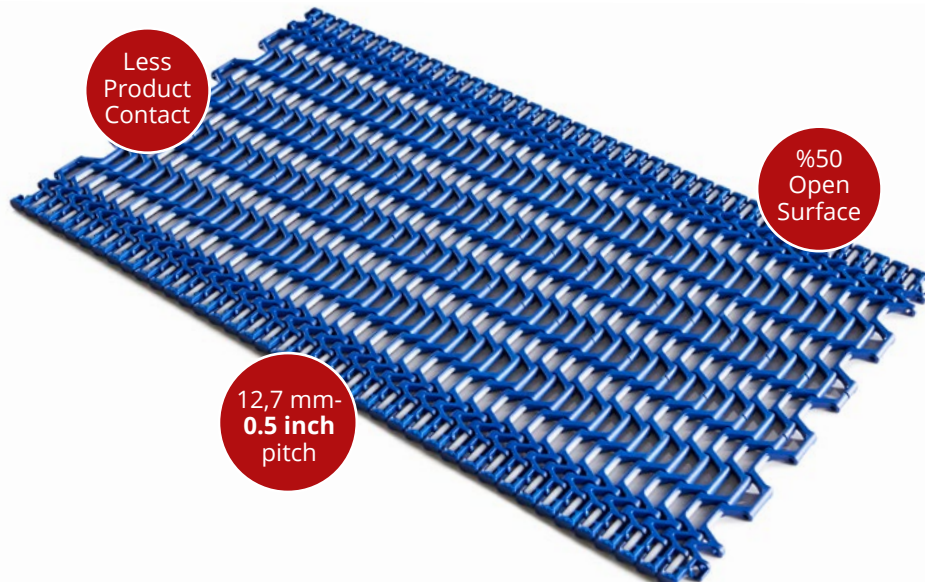

MD127 Series *Technical Specifications*



Z36

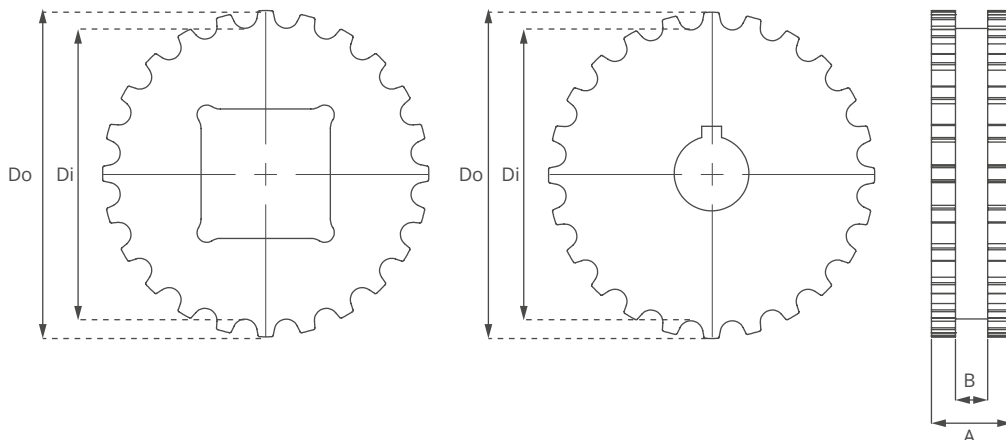

MD127 GAP%50 Serie / Machined Sprockets Dimensions

NO. TEETH	Di mm/inch	Do mm/inch	B mm/inch	A mm/inch	Square Bore (Q) mm/inch	Round Bore (R) mm/inch	PRODUCT CODE	
							Square Type (Q)	Round Type (R)
Z19	70,9 / 2.79	80,8 / 3.18	10 / 0.39	25 / 1.0	20 / 0.78	25 / 1	MD127G50SQZ19	MD127G50SRZ19
Z24	91,3 / 3.59	101,6 / 4.00	10 / 0.39	25 / 1.0	25 / 1	25-40 / 1-1.50	MD127G50SQZ24	MD127G50SRZ24
Z36	140,5 / 5.53	150,5 / 5.93	10 / 0.39	25 / 1.0	40 / 1.57	25-400 / 1-1.50	MD127G50SQZ36	MD127G50SRZ36

*All required sprockets produced by CNC.

*Other sprockets and hub sizes are manufactured up to request.

*POM (Acetal) and PA (Polyamide) sprockets raw material is available on request.

***Machined Split Sprockets are available for each size.**



HC127 C

Pitch:	12,7 mm / 0.5 inch
Belt Surface:	Close, Smooth Surface
Minimum Width:	101,6 mm / 4 inch
Open Area (%):	0%
Flight:	No
Sidewall:	No
Rod:	Ø4,5 mm / 0.177 inch
Approved:	FDA and EU
Curve:	No
Color:	Additional colors available
Cleanability:	Excellent
Belt Thickness:	8 mm / 0.315 inch

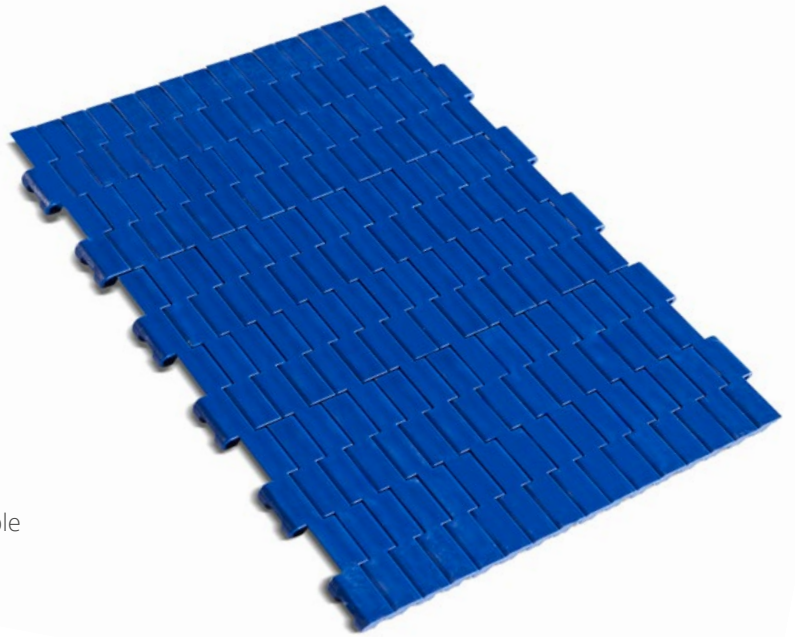

Product Features and Functional Benefits

- Easy to clean reduces downtime for cleaning time 80%.
- Unique sprocket engagement - higher product load and longer conveyors.
- Close transfer applications.
- Reduces bacteria growth.

Available Moulded Module Sizes

- 203,2 mm / **8 inch** module
- 101,6 mm / **4 inch** module

HC127 C / Technical Information

BELT MATERIAL	BELT STRENGTH				TEMPERATURE		BELT WEIGHT Kg/m ² / lb/ft ²
	Straight		Curve		°C / °F (min.)	°C/°F (max.)	
	N/m	lb/ft	N/m	lb/ft			
Polypropylene	2750	188	-	-	+5 / +41	+90 / +194	3,8 / 0.78
Polyethylene	-	-	-	-	-	-	-
Acetal	5170	354	-	-	-43 / -45.4	+110 / +230	5,7 / 1.17

- Belt strength and temperature values are maximum on the table.



Super Clean

Open Double Hinge



HC127 Series *Technical Specifications*



Z36

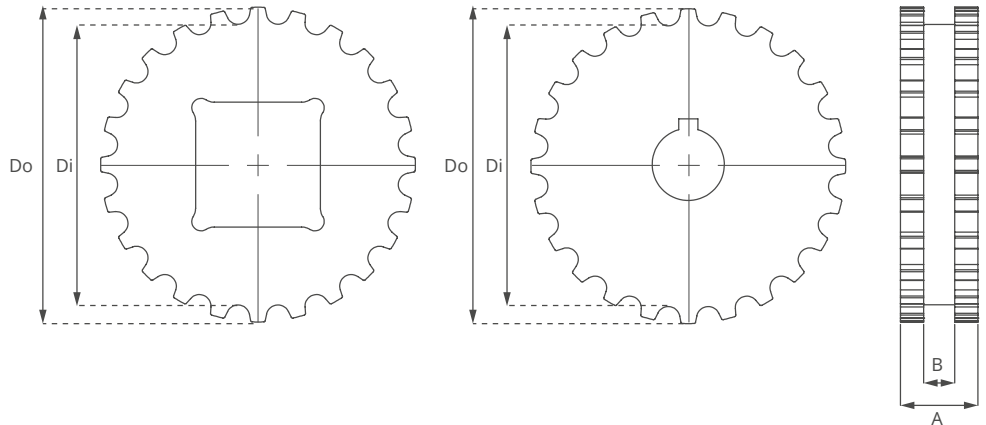

HC127 C Serie / Machined Sprockets Dimensions

NO. TEETH	Di mm/inch	Do mm/inch	B mm/inch	A mm/inch	Square Bore (Q) mm/inch	Round Bore (R) mm/inch	PRODUCT CODE	
							Square Type (Q)	Round Type (R)
Z19	69,4 / 2.73	79,3 / 3.12	10 / 0.36	25 / 1.0	20 / 0.78	25 / 1	HC127SQZ19	HC127SRZ19
Z24	89,8 / 3.54	100,0 / 3.94	10 / 0.36	25 / 1.0	25 / 1	25-30 / 1-1.25	HC127SQZ24	HC127SRZ24
Z36	139,0 / 5.47	149,4 / 5.88	10 / 0.36	25 / 1.0	40 / 1.57	25-30 / 1-1.25	HC127SQZ36	HC127SRZ36

*All required sprockets produced by CNC.

*Other sprockets and hub sizes are manufactured up to request.

*POM (Acetal) and PA (Polyamide) sprockets raw material is available on request.

***Machined Split Sprockets are available for each size.**





MODUTECH

XP254 C

Pitch:	25,4 mm / 1 inch
Belt Surface:	Close, Smooth Surface
Minimum Width:	50 mm / 1.97 inch
Open Area (%):	0%
Flight:	Yes (T25, T50, T75, T100)
Sidewall:	Yes (h=25 mm, h=50 mm, h=75 mm, h=100 mm)
Rod:	Ø4,5 mm / 0.177 inch - Self Lock
Approved:	FDA and EU
Curve:	No
Color:	Additional colors available
Cleanability:	Good
Belt Thickness:	8.8 mm / 0.346 inch

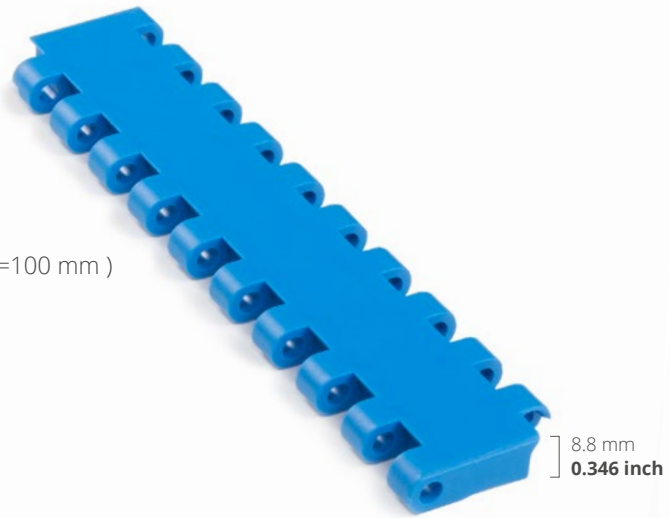

Product Features and Functional Benefits

- Unique sprocket engagement - higher product load and longer conveyors.
- Unique sprocket engagement reduces pulsation and increases load capacity.
- Close transfer applications.
- Extra power, bi-directional belt for long conveyors.
- Chamfered belt edges.

Available Moulded Module Sizes

- 152,4 mm / **6 inch** module
- 76,2 mm / **3 inch** module

XP254 C / Technical Information

BELT MATERIAL	BELT STRENGTH				TEMPERATURE		BELT WEIGHT
	Straight		Curve		°C / °F (min.)	°C / °F (max.)	Kg/m ² / lb/ft ²
	N/m	lb/ft	N/m	lb/ft			
Polypropylene	18400	1260.80	-	-	+5 / +41	+90 / +194	5,50 / 1.13
Polyethylene	9100	623.55	-	-	-73 / -99.4	+66 / +150.8	5,80 / 1.19
Acetal	32100	2199.55	-	-	-43 / -45.4	+110 / +230	7,90 / 1.62

- Belt strength and temperature values are maximum on the table.



XP254 C

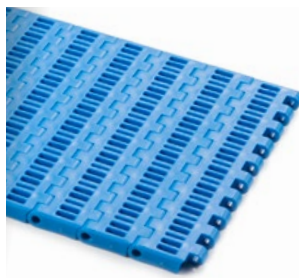

XP254 PR%22



XP254 FG



XP254 Series *Technical Specifications*

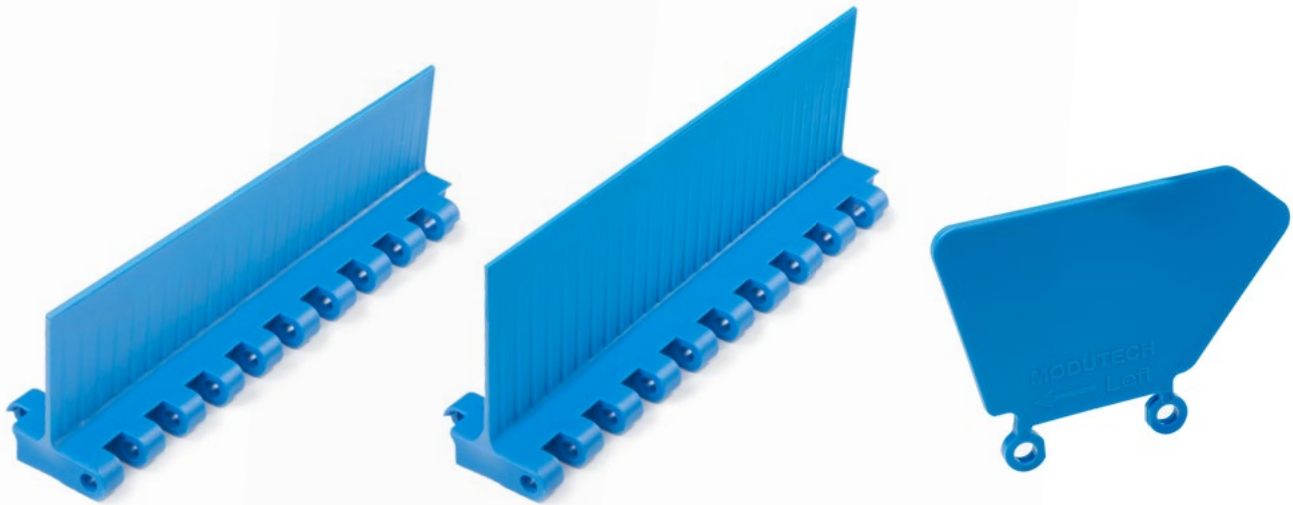

XP254 Series / Flight & Sidewall Dimensions

XP254 Series / Flights & Sidewalls				
PRODUCT CODE	Flight Height (mm/ inch)	Flight Width (mm/ inch)	PRODUCT CODE	Sidewall Height (mm/ inch)
XP254T25	25 / 1	152,4 / 6	XP254SW25	25 / 1
XP254T50	50 / 2	152,4 / 6	XP254SW50	50 / 2
XP254T75	75 / 3	152,4 / 6	XP254SW75	75 / 3
XP254T100	100 / 4	152,4 / 6	XP254SW100	100 / 4

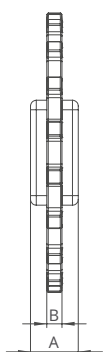
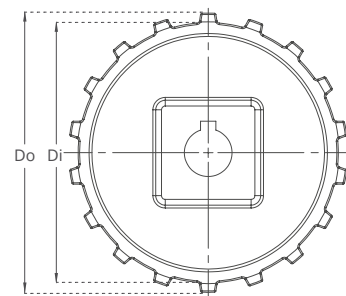
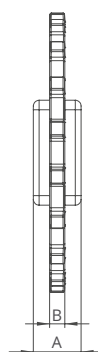
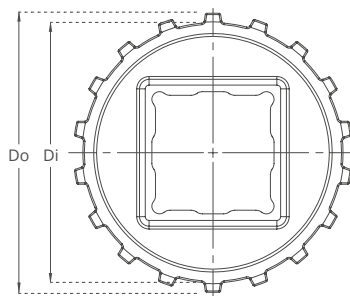

XP254 Series / Standard Sprockets Dimensions

NO. TEETH	Di mm/ inch	Do mm/ inch	B mm/ inch	A mm/ inch	Square Bore (Q) mm/ inch	Round Bore (R) mm/ inch	PRODUCT CODE	
							Square Type (Q)	Round Type (R)
Z8	53,2 / 2.09	64,0 / 2.52	8 / 0.31	25 / 1	25 / 1	25-30 / 1-1.25	XP254SQZ8*PA	XP254SRZ8*PA
Z10	71,6 / 2.82	82,5 / 3.25	8 / 0.31	25 / 1	40 / 1.5	25-30 / 1-1.25	XP254SQZ10*PA	XP254SRZ10*PA
Z12	89,0 / 3.50	99,5 / 3.92	8 / 0.31	25 / 1	40 / 1.5	25-30 / 1-1.25	XP254SQZ12*PA	XP254SRZ12*PA
Z15	114,0 / 4.49	124,0 / 4.88	8 / 0.31	25 / 1	40-60 / 1.5-2.5	25-30 / 1-1.25	XP254SQZ15*PA	XP254SRZ15*PA
Z18	136,4 / 5.37	146,4 / 5.76	8 / 0.31	25 / 1	40-60 / 1.5-2.5	25-30 / 1-1.25	XP254SQZ18*PA	XP254SRZ18*PA



- Split moulded sprockets are available for XP254 Z15 & Z18!

*Other sprockets and hub sizes are manufactured up to request. *POM (Acetal) and PP (Polypropylene) sprockets raw material is available on request.

*Machined Split Sprockets are available for each size.



MODUTECH

XP254 CR

Pitch:	25,4 mm / 1 inch
Belt Surface:	Close, Non Slip Surface
Minimum Width:	76,2 mm / 3 inch
Open Area (%):	0%
Flight:	No
Sidewall:	No
Rod:	Ø4,5 mm / 0.177 inch - Self Lock
Approved:	No
Curve:	No
Color:	Additional colors available
Cleanability:	Good
Belt Thickness:	9,3 mm / 0.366 inch

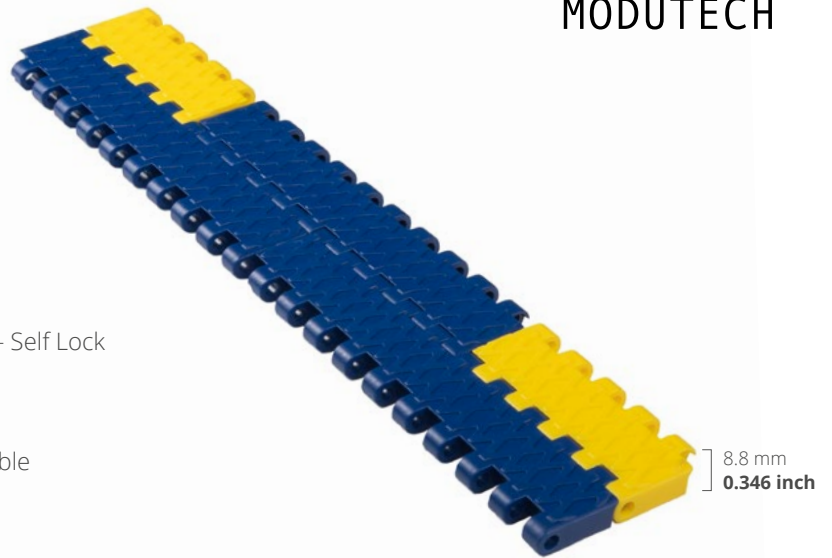

Product Features and Functional Benefits

- Chamfered belt edges.
- Reinforced bottom surface - higher product load and longer conveyors.
- Unique sprocket engagement reduces pulsation and increases load capacity.
- Close transfer applications.
- Extra power, bi-directional belt for long conveyors.
- Safety walking top surface.

Available Moulded Module Sizes

- 152,4 mm / **6 inch** module
- 76,2 mm / **3 inch** module

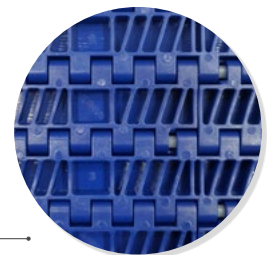

Reinforced Bottom Surface

XP254 CR / Technical Information

BELT / PIN MATERIAL	BELT STRENGTH				TEMPERATURE		BELT WEIGHT
	Straight		Curve		°C / °F (min.)	°C / °F (max.)	
	N/m	lb/ft	N/m	lb/ft			Kg/m ² / lb/ft ²
Acetal / PA6	40250	2758	-	-	-43 / -45.4	+110 / +230	8,1 / 1.67

- Belt strength and temperature values are maximum on the table.

XP254 FLT CR

Pitch:	25,4 mm / 1 inch
Belt Surface:	Close, Smooth Surface
Minimum Width:	76,2 mm / 3 inch
Open Area (%):	0%
Flight:	No
Sidewall:	No
Rod:	Ø4,5 mm / 0.177 inch - Self Lock
Approved:	No
Curve:	No
Color:	Additional colors available
Cleanability:	Good
Belt Thickness:	8,8 mm / 0.346 inch

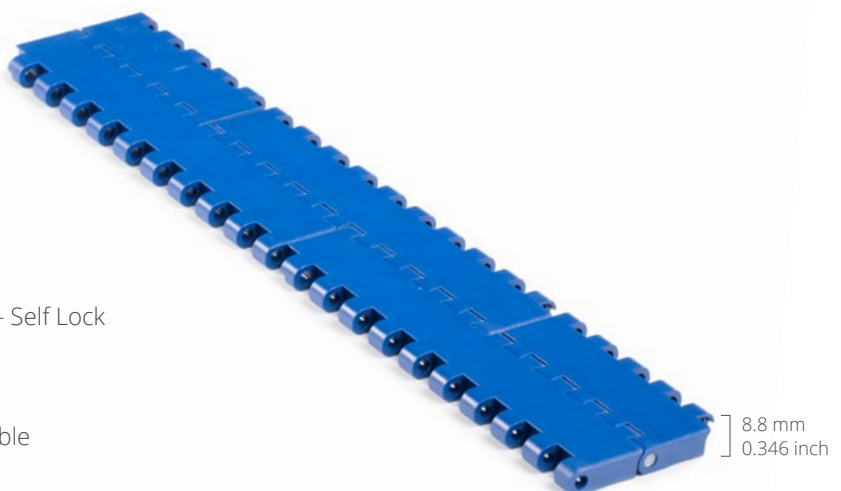

XP254 Series *Technical Specifications*

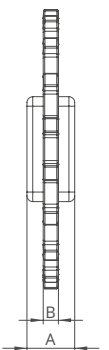
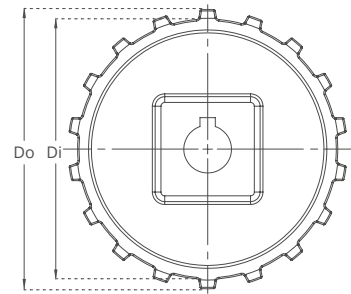
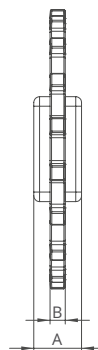
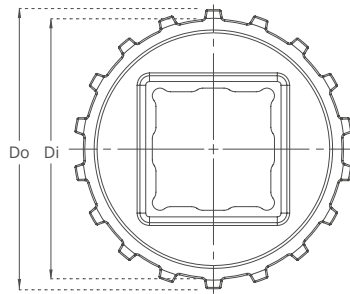

- Split moulded sprockets are available for XP254 Z15 & Z18!

XP254 Series / Standard Sprockets Dimensions

NO. TEETH	Di mm/inch	Do mm/inch	B mm/inch	A mm/inch	Square Bore (Q) mm/inch	Round Bore (R) mm/inch	PRODUCT CODE	
							Square Type (Q)	Round Type (R)
Z8	53,2 / 2.09	64,0 / 2.52	8 / 0.31	25 / 1	25 / 1	25-30 / 1-1.25	XP254SQZ8*PA	XP254SRZ8*PA
Z10	71,6 / 2.82	82,5 / 3.25	8 / 0.31	25 / 1	40 / 1.5	25-30 / 1-1.25	XP254SQZ10*PA	XP254SRZ10*PA
Z12	89,0 / 3.50	99,5 / 3.92	8 / 0.31	25 / 1	40 / 1.5	25-30 / 1-1.25	XP254SQZ12*PA	XP254SRZ12*PA
Z15	114,0 / 4.49	124,0 / 4.88	8 / 0.31	25 / 1	40-60 / 1.5-2.5	25-30 / 1-1.25	XP254SQZ15*PA	XP254SRZ15*PA
Z18	136,4 / 5.37	146,4 / 5.76	8 / 0.31	25 / 1	40-60 / 1.5-2.5	25-30 / 1-1.25	XP254SQZ18*PA	XP254SRZ18*PA

*Other sprockets and hub sizes are manufactured up to request. *POM (Acetal) and PP (Polypropylene) sprockets raw material is available on request.

***Machined Split Sprockets are available for each size.**



Safety first because Modutech cares about you!
Non-skid surface offers safety through walking for corrugated industry .



MODUTECH

EC254 C (Easy Clean)

Pitch:	25,4 mm / 1 inch
Belt Surface:	Close, Smooth Surface
Minimum Width:	152,4 mm / 6 inch
Open Area (%):	0%
Flight:	Yes (T25, T50, T75, TC75, TCH75, T100, TNC50, TNC100)
Sidewall:	Yes (h=25 mm, h=50 mm, h=75 mm, h=100 mm)
Rod:	Ø5 mm / 0.197 inch - Self Lock
Approved:	FDA and EU
Curve:	No
Color:	Additional colors available
Cleanability:	Excellent
Belt Thickness:	10 mm / 0.394 inch



Product Features and Functional Benefits

- Easy to clean reduces downtime for cleaning time 70%.
- Unique sprocket engagement - higher product load and longer conveyors.
- Close transfer applications.
- Reduces bacteria growth.

Available Moulded Module Sizes

- 152,4 mm / **6 inch** module
- 76,2 mm / **3 inch** module
- 45 mm / **1.77 inch** module
- 30 mm / **1.18 inch** module

EC254 C / Technical Information

BELT MATERIAL	BELT STRENGTH				TEMPERATURE		BELT WEIGHT Kg/m ² / lb/ft ²
	Straight		Curve		°C / °F (min.)	°C / °F (max.)	
	N/m	lb/ft	N/m	lb/ft			
Polypropylene	15400	1055	-	-	+5 / +41	+90 / +194	4,9 / 1.00
Polyethylene	9240	603	-	-	-73 / -99.4	+66 / +150.8	5,2 / 1.05
Acetal	25150	1723	-	-	-43 / -45.4	+110 / +230	7,3 / 1.49

- Belt strength and temperature values are maximum on the table.

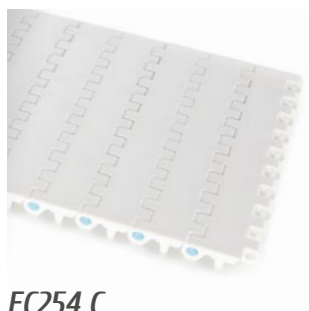

EC254 C



EC254 PR%16

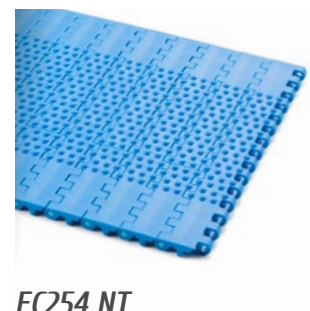

EC254 NT

1 Inch - 25.4mm Modular Belt Series



EC254 Series *Accessories and Technical Specifications*

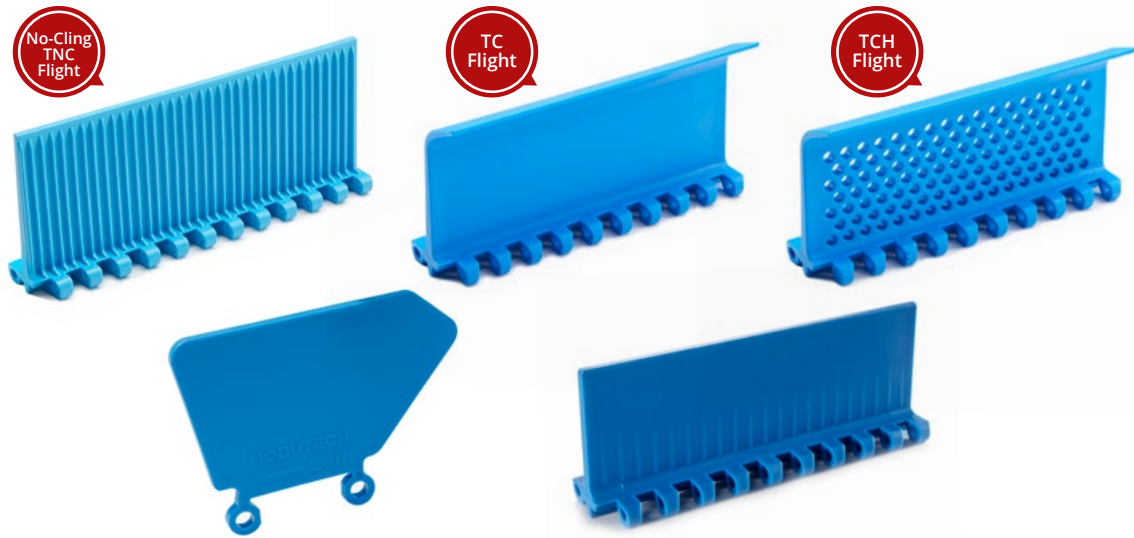

EC254 Series / Flight & Sidewall Dimensions

EC254 Series / Flights & Sidewalls				
PRODUCT CODE	Flight Height (mm/ <i>inch</i>)	Flight Width (mm/ <i>inch</i>)	PRODUCT CODE	Sidewall Height (mm/ <i>inch</i>)
EC254T25	25 / 1	152,4 / 6	EC254SW25	25 / 1
EC254T50	50 / 2	152,4 / 6	EC254SW50	50 / 2
EC254T75	75 / 3	152,4 / 6	EC254SW75	75 / 3
EC254T100	100 / 4	152,4 / 6	EC254SW100	100 / 4
EC254TC75	75 / 3	152,4 / 6	-	-
EC254TCH75	75 / 3	152,4 / 6	-	-
EC254TNC50	50 / 2	152,4 / 6	-	-
EC254TNC100	100 / 4	152,4 / 6	-	-

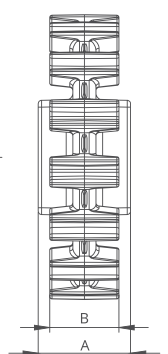
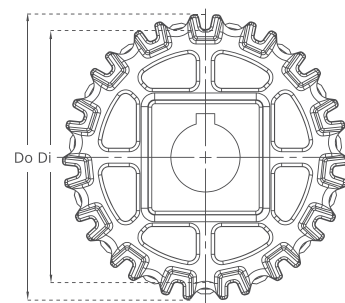
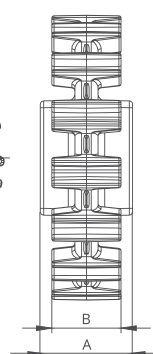
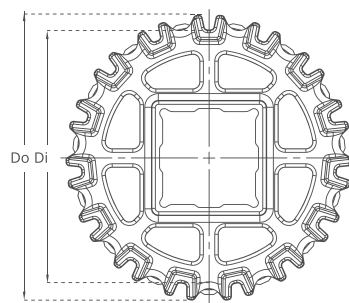

EC254 Series / Standard Sprockets Dimensions

NO. TEETH	Di mm/ <i>inch</i>	Do mm/ <i>inch</i>	B mm/ <i>inch</i>	A mm/ <i>inch</i>	Square Bore (Q) mm/ <i>inch</i>	Round Bore (R) mm/ <i>inch</i>	PRODUCT CODE	
							Square Type (Q)	Round Type (R)
Z8	51,6 / 2.03	64,6 / 2.54	30 / 1.18	40 / 1.57	25 / 1	25 / 1	EC254SQZ8*POM	EC254SRZ8*POM
Z10	68,8 / 2.71	81,8 / 3.22	30 / 1.18	40 / 1.57	40 / 1.5	25-30 / 1-1.25	EC254SQZ10*POM	EC254SRZ10*POM
Z12	85,5 / 3.37	98,8 / 3.89	30 / 1.18	40 / 1.57	40 / 1.5	25-30 / 1-1.25	EC254SQZ12*POM	EC254SRZ12*POM
Z15	111,1 / 4.37	124,1 / 4.89	30 / 1.18	40 / 1.57	40 / 1.5	25-30 / 1-1.25	EC254SQZ15*POM	EC254SRZ15*POM
Z18	136,1 / 5.36	149,1 / 5.87	30 / 1.18	40 / 1.57	40 / 1.5	25-30 / 1-1.25	EC254SQZ18*POM	EC254SRZ18*POM

*Other sprockets and hub sizes are manufactured up to request. *PA (Polyamide) and PP (Polypropylene) sprockets raw material is available on request.

***Machined Split Sprockets are available for each size.**



MODUTECH

MD254 FG

Pitch:	25,4 mm / 1 inch
Belt Surface:	Open, Smooth Surface
Minimum Width:	50 mm / 1.97 inch
Open Area (%):	33%. (Biggest opening 5,5 x 7 mm)
Flight:	Yes (T25, T50, TC50, TCH50, TNC75, TNC100, T75, T100)
Sidewall:	Yes (h=25mm, h=50mm, h=75mm, h=100mm)
Rod:	Ø 5 mm / 0.197 inch - Self Lock
Approved:	FDA and EU
Curve:	No
Color:	Additional colors available
Cleanability:	Good
Belt Thickness:	10 mm / 0.394 inch



Product Features and Functional Benefits

- Belt provides optimal open area for drainage and airflow.
- Less friction and product contact for easy cooking, cooling and freezing of products.
- Reduced dirt and oxide build due to self cleaning surface.
- Bi-directional belt for long conveyors.
- Stainless steel pins option for high temperature applications.
- Easy to clean reduces downtime for cleaning time 70%.
- Stainless steel pins option reduce belt elongation for high temperature application.

Available Moulded Module Sizes

- 200 mm / **7.87 inch** module
- 100 mm / **3.94 inch** module
- 50 mm / **1.97 inch** module
- 33 mm / **1.30 inch** module

MD254 FG / Technical Information

BELT MATERIAL	BELT STRENGTH				TEMPERATURE		BELT WEIGHT Kg/m ² / lb/ft ²
	Straight		Curve		°C / °F (min.)	°C / °F (max.)	
	N/m	lb/ft	N/m	lb/ft			
Polypropylene	15400	1055	-	-	+5 / +41	+90 / +194	4,6 / 0.94
Polyethylene	8800	603	-	-	-73 / -99.4	+66 / +150.8	5,1 / 1.04
Acetal	27170	1861	-	-	-43 / -45.4	+110 / +230	7,1 / 1.45

- Belt strength and temperature values are maximum on the table.

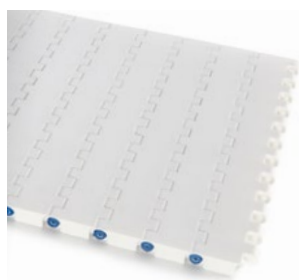

MD254 C

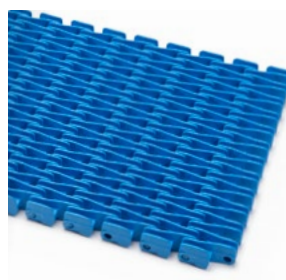

MD254 RR



MD254 GAP%48



MD254 FG

1 Inch - 25.4mm Modular Belt Series



MD254 Series Accessories and Technical Specifications

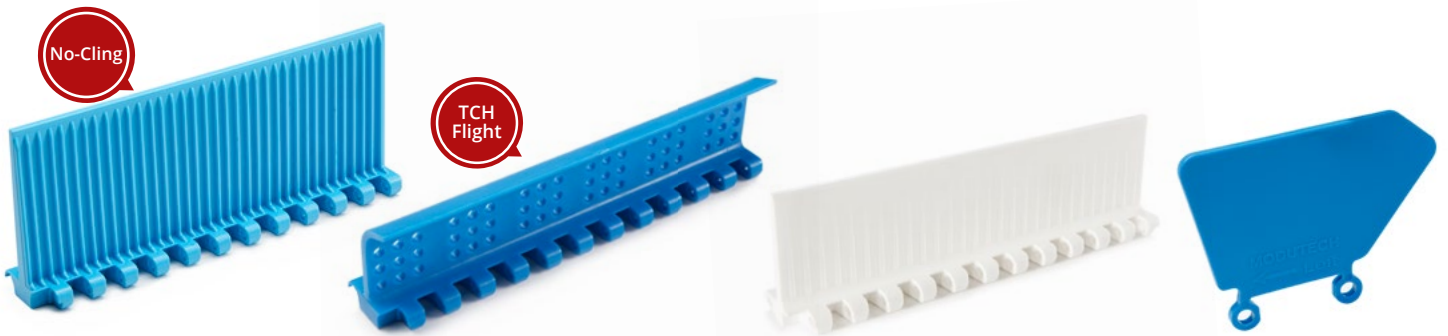

MD254 Series / Flight & Sidewall Dimensions

MD254 Series / Flights & Sidewalls				
PRODUCT CODE	Flight Height (mm/ inch)	Flight Width (mm/ inch)	PRODUCT CODE	Sidewall Height (mm/ inch)
MD254T25	25 / 1	200 / 7.87	MD254SW25	25 / 1
MD254T50	50 / 2	200 / 7.87	MD254SW50	50 / 2
MD254T75	75 / 3	200 / 7.87	MD254SW75	75 / 3
MD254T100	100 / 4	200 / 7.87	MD254SW100	100 / 4
MD254TC50	50 / 2	200 / 7.87	-	-
MD254TCH50	50 / 2	200 / 7.87	-	-
MD254TNC75	75 / 3	200 / 7.87	-	-
MD254TNC100	100 / 4	200 / 7.87	-	-

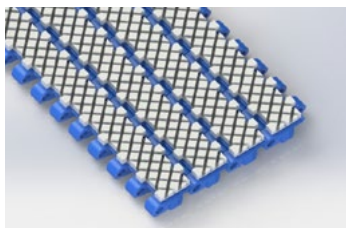

MD254 GT / Friction Top Surface

BELT TYPE	Belt Material	Belt Colour	Rubber Insert Colour	Module Width	
				mm	inch
MD254 GT	PP	White/Blue/ Gray	White/Black	200	7,87



Z12

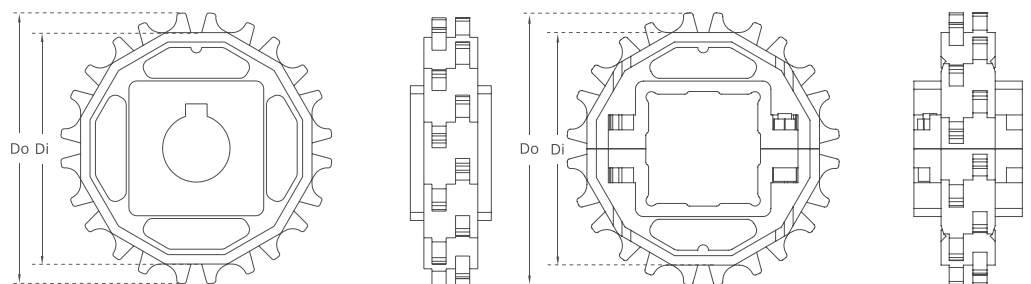

Split moulded sprockets are available.

MD254 Series / Standard Sprockets Dimensions

NO. TEETH	Di mm/ inch	Do mm/ inch	B mm/ inch	A mm/ inch	Square Bore (Q) mm/ inch	Round Bore (R) mm/ inch	PRODUCT CODE	
							Square Type (Q)	Round Type (R)
Z8	52,0 / 2.05	67,0 / 2.64	6 / 0.24	30 / 1.18	25 / 1	25 / 1	MD-TR254SQ25Z8*POM	MD-TR254SRZ8*POM
Z10	69,0 / 2.72	84,0 / 3.31	6 / 0.24	30 / 1.18	40 / 1.5	25-30 / 1-1.25	MD-TR254SQZ10*POM	MD-TR254SRZ10*POM
Z12	85,84 / 3.38	100,84 / 3.97	6 / 0.24	30 / 1.18	40 / 1.5	25-30 / 1-1.25	MD-TR254SQZ12*POM	MD-TR254SRZ12*POM
Z15	110,8 / 4.36	125,8 / 4.95	6 / 0.24	30 / 1.18	40 / 1.5	25-30 / 1-1.25	MD-TR254SQZ15*POM	MD-TR254SRZ15*POM
Z16	119,1 / 4.69	134,1 / 5.28	6 / 0.24	30 / 1.18	40 / 1.5	25-30 / 1-1.25	MD-TR254SQZ16*POM	MD-TR254SRZ16*POM
Z18	135,63 / 5.34	150,58 / 5.93	6 / 0.24	30 / 1.18	40 / 1.5	25-30 / 1-1.25	MD-TR254SQZ18*POM	MD-TR254SRZ18*POM

*Other sprockets and hub sizes are manufactured up to request. *PA (Polyamide) and PP (Polypropylene) sprockets raw material is available on request.

*Machined Split Sprockets are available for each size.



MODUTECH

EC508 C (Easy Clean)

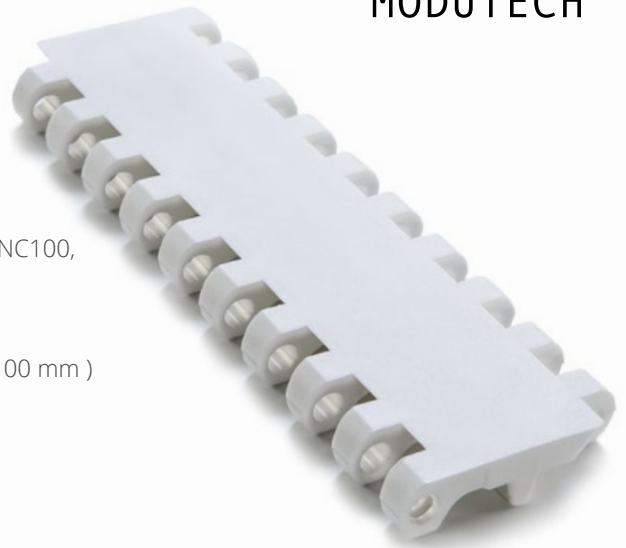

Pitch:	50,8 mm / 2 inch
Belt Surface:	Close, Smooth Surface
Minimum Width:	100 mm / 3.94 inch
Open Area (%):	0%
Flight:	Yes (T25, T50, T75, T100, T150, TNC50, TNC100, TC75, TC100, TC150, TCC75, TCC100, TCC150, TCCH100)
Sidewall:	Yes (h=25 mm, h=50 mm, h=75 mm, h=100 mm)
Rod:	Ø7 mm / 0.276 inch - Self Lock
Approved:	FDA and EU
Curve:	No
Color:	Additional colors available
Cleanability:	Excellent
Belt Thickness:	16 mm / 0.630 inch

Product Features and Functional Benefits

- Easy to clean reduces downtime for cleaning time 70%.
- Close transfer applications.
- Reduces bacteria growth.
- Unique sprocket engagement - higher product load and longer conveyors.
- Strong and thick product supports allow more load without breaking.
- Impact resistance to withstand heavy objects falling into the belt.

Available Moulded Module Sizes

- 200 mm / **7.87 inch** module
- 100 mm / **3.94 inch** module
- 60 mm / **2.36 inch** module
- 40 mm / **1.57 inch** module

EC508 C / Technical Information

BELT MATERIAL	BELT STRENGTH				TEMPERATURE		BELT WEIGHT Kg/m ² / lb/ft ²
	Straight		Curve		°C / °F (min.)	°C / °F (max.)	
	N/m	lb/ft	N/m	lb/ft			
Polypropylene	19800	1356	-	-	+5 / +41	+90 / +194	9,0 / 1.85
Polyethylene	11000	753	-	-	-73 / -99.4	+66 / +150.8	9,4 / 1.93
Acetal	33000	2260	-	-	-43 / -45.4	+110 / +230	13,5 / 2.77

- Belt strength and temperature values are maximum on the table.



EC508 C

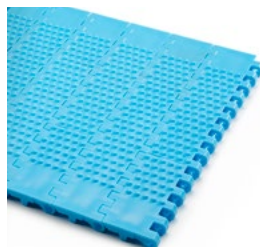

EC508 NT



EC508 DT



EC508 FG

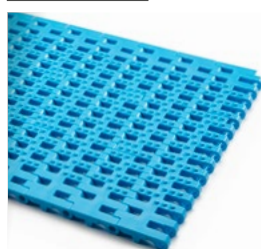

EC508 FG-NT



EC508 PR%22



EC508 PR%11



EC508 PR%13



EC508 Series Accessories and Technical Specifications

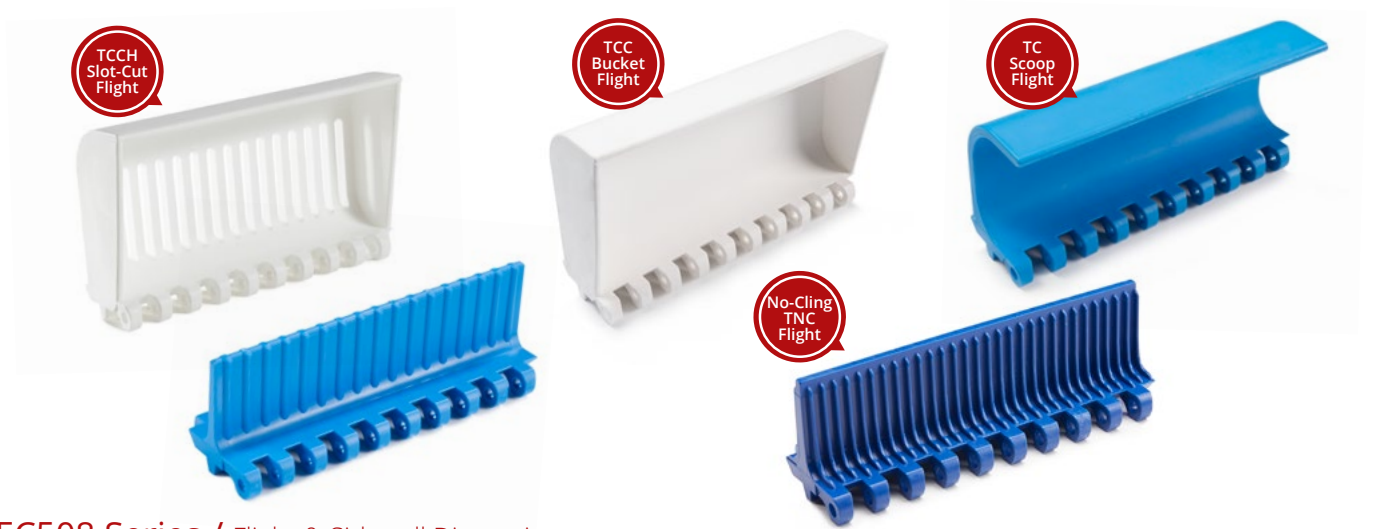

EC508 Series / Flight & Sidewall Dimensions

EC508 Series / Flights & Sidewalls

PRODUCT CODE	Flight Height (mm/ <i>inch</i>)	Flight Width (mm/ <i>inch</i>)	PRODUCT CODE	Sidewall Height (mm/ <i>inch</i>)
EC508T25	25 / 1	200 / 7.87	EC508SW25	25 / 1
EC508T50	50 / 2	200 / 7.87	EC508SW50	50 / 2
EC508T75	75 / 3	200 / 7.87	EC508SW75	75 / 3
EC508T100	100 / 4	200 / 7.87	EC508SW100	100 / 4
EC508T150	150 / 6	200 / 7.87	-	-
EC508TC75	75 / 3	200 / 7.87	-	-
EC508TC100	100 / 4	200 / 7.87	-	-
EC508TC150	150 / 6	200 / 7.87	-	-
EC508TCC75	75 / 3	200 / 7.87	-	-
EC508TCC100	100 / 4	200 / 7.87	-	-
EC508TCC150	150 / 6	200 / 7.87	-	-
EC508TNC100	100 / 4	200 / 7.87	-	-
EC508TCH100	100 / 4	200 / 7.87	-	-
EC508TCCH100	100 / 4	200 / 7.87	-	-

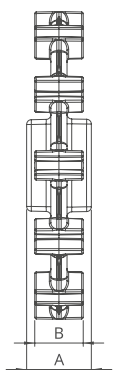
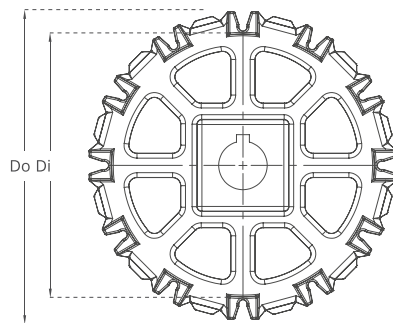
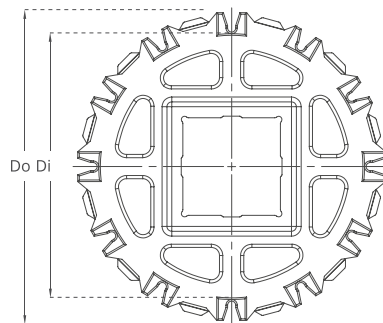
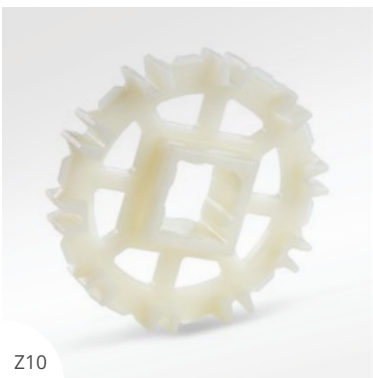

EC508 Series / Standard Sprockets Dimensions

NO. TEETH	Di mm/ <i>inch</i>	Do mm/ <i>inch</i>	B mm/ <i>inch</i>	A mm/ <i>inch</i>	Square Bore(Q) mm/ <i>inch</i>	Round Bore(R) mm/ <i>inch</i>	PRODUCT CODE	
							Square Type (Q)	Round Type (R)
Z6	73,0 / 2.87	90,0 / 3.54	30 / 1.18	40 / 1.57	40 / 1.5	25-30 / 1-1.25	EC508SQZ6*PA	EC508SRZ6*PA
Z8	107,5 / 4.23	124,5 / 4.90	30 / 1.18	40 / 1.57	40 / 1.5	25-30 / 1-1.25	EC508SQZ8*PA	EC508SRZ8*PA
Z10	141,5 / 5.57	158,0 / 6.22	30 / 1.18	40 / 1.57	40-60 / 1.5-2.5	25-30 / 1-1.25	EC508SQZ10*PA	EC508SRZ10*PA
Z12	175,2 / 6.90	191,2 / 7.53	30 / 1.18	40 / 1.57	40-60 / 1.5-2.5	25-30 / 1-1.25	EC508SQZ12*PA	EC508SRZ12*PA

*Other sprockets and hub sizes are manufactured up to request.

*POM (Acetal) and PP (Polypropylene) sprockets raw material is available on request.

*Machined Split Sprockets are available for each size.



MODUTECH

MD508 FG (Heavy Duty)

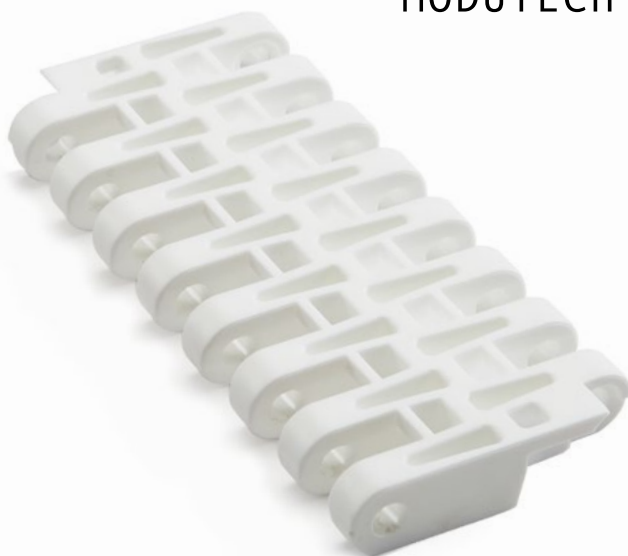

Pitch:	50,8 mm / 2 inch
Belt Surface:	Open, Smooth Surface
Minimum Width:	150 mm / 5.90 inch
Open Area (%):	34%. (Biggest opening 6 x 19,8 mm)
Flight:	Yes (T50, T100, T150)
Sidewall:	No
Rod:	Ø7 mm / 0.275 inch - Self Lock
Approved:	FDA and EU
Curve:	No
Color:	Additional colors available
Cleanability:	Good
Belt Thickness:	16 mm / 0.629 inch

Product Features and Functional Benefits

- Belt provides optimal open area for drainage and airflow.
- Unique sprocket engagement reduces pulsation and increases load capacity.
- High power, bi-directional belt for long conveyors.
- Unique sprocket engagement - higher product load and longer conveyors.
- Strong and thick product supports allow more load without breaking.
- Impact resistance to with stand heavy objects falling on the belt.

Available Moulded Module Sizes

- 150 mm / **5.90 inch** module

MD508 FG / Technical Information

BELT MATERIAL	BELT STRENGTH				TEMPERATURE		BELT WEIGHT
	Straight		Curve		°C / °F (min.)	°C / °F (max.)	Kg/m ² / lb/ft ²
	N/m	lb/ft	N/m	lb/ft			
Polypropylene	28600	1959	-	-	+5 / +41	+90 / +194	6,8 / 1.39
Polyethylene	19800	1356	-	-	-73 / -99.4	+66 / +150.8	7,2 / 1.48
Acetal	38500	2637	-	-	-43 / -45.4	+110 / +230	10,2 / 2.09

- Belt strength and temperature values are maximum on the table.



MD508 C



MD508 FG



MD508 PR%25

2 Inch - 50,8mm Modular Belt Series



MD508 Series Accessories and Technical Specifications



MODUTECH

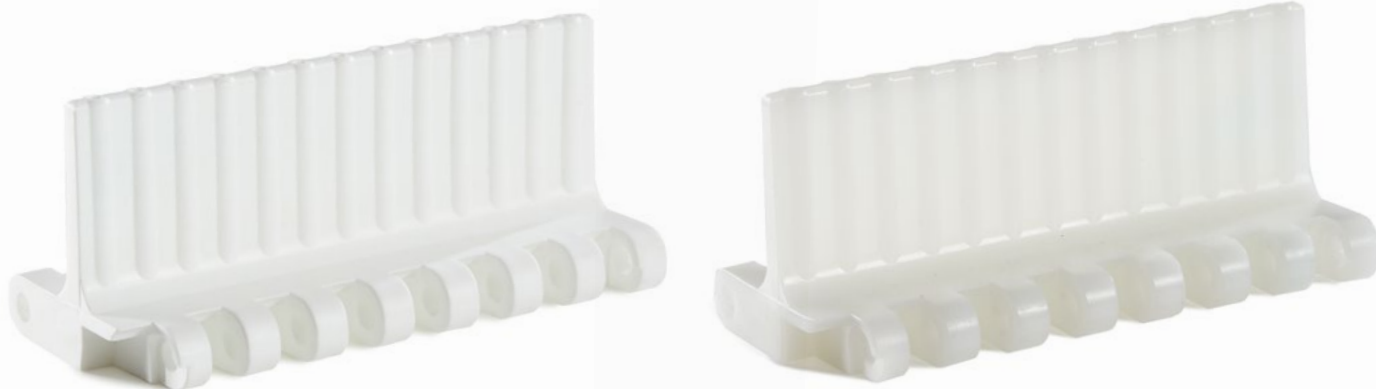

MD508 Series / Flight Dimensions

MD508 Series / Flights				
PRODUCT CODE	Flight Height (mm/ inch)	Flight Width (mm/ inch)	PRODUCT CODE	Sidewall Height (mm/ inch)
MD508T50	50 / 2	150 / 5.90	-	-
MD508T100	100 / 4	150 / 5.90	-	-
MD508T150	150 / 6	150 / 5.90	-	-



Z12

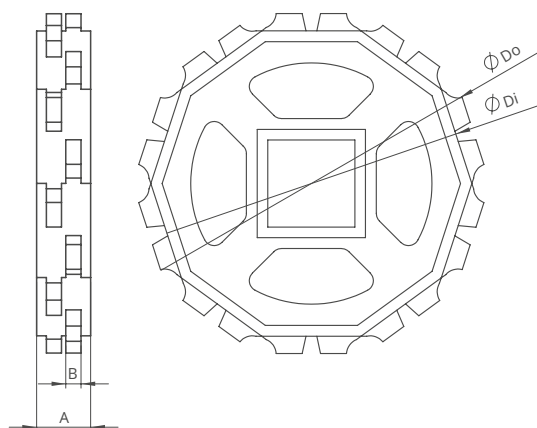
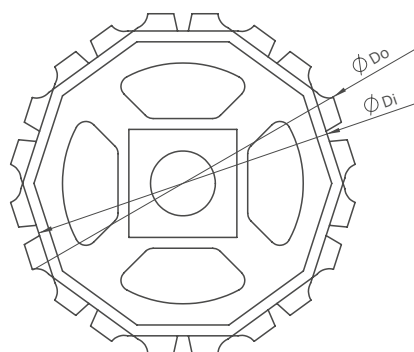

MD508 Series / Standard Sprockets Dimensions

NO.TEETH	Di mm/ inch	Do mm/ inch	B mm/ inch	A mm/ inch	Square Bore (Q) mm/ inch	Round Bore (R) mm/ inch	PRODUCT CODE	
							Square Type (Q)	Round Type (R)
Z8	107,37 / 4.23	127,35 / 5.01	7 / 0.27	40 / 1.57	40 / 1.5	25-30 / 1-1.25	MD508SQZ8*POM	MD508SRZ8*POM
Z10	141,27 / 5.56	160,14 / 6.30	7 / 0.27	40 / 1.57	40-60 / 1.5-2.5	25-30 / 1-1.25	MD508SQZ10*POM	MD508SRZ10*POM
Z12	174,71 / 6.87	193,24 / 7.61	7 / 0.27	40 / 1.57	40-60 / 1.5-2.5	25-30 / 1-1.25	MD508SQZ12*POM	MD508SRZ12*POM

*Other sprockets and hub sizes are manufactured up to request.

*PA (Polyamide) and PP (Polypropylene) sprockets raw material is available on request.

***Machined Split Sprockets are available for each size.**



MODUTECH

HP508 RR

Pitch:	50,8 mm / 2 inch
Belt Surface:	Open, Raised Rib Surface
Minimum Width:	152,4 mm / 6 inch
Open Area (%):	36%. (Biggest opening 3,5 x 18,5 mm)
Flight:	No
Sidewall:	No
Rod:	Ø7 mm / 0.275 inch - Self Lock
Approved:	FDA and EU
Curve:	No
Color:	Additional colors available
Cleanability:	Good
Belt Thickness:	24 mm / 0.945 inch
Comb:	Yes



Product Features and Functional Benefits

- Less friction and product contact for easy cooking, cooling and freezing of products.
- Reduces back line pressure with up to 70%.
- Reduced dirt and oxide build up due to self cleaning surface.
- Finger plate for trouble free transfer.
- Unique sprocket engagement reduces pulsation and increases load capacity.

Available Moulded Module Sizes

- 152,4 mm / **6 inch** module
- 76,2 mm / **3 inch** module

HP508 RR / Technical Information

BELT MATERIAL	BELT STRENGTH				TEMPERATURE		BELT WEIGHT
	Straight		Curve		°C (min.) - °F (min.)	°C (max.) - °F (max.)	Kg/m ² - lb/ft ²
	N/m	lb/ft	N/m	lb/ft			
Polypropylene	34200	2343	-	-	+5 / +42.8	+90 / +194	8,9 - 1.82
PPHomopolymer	34200	2343	-	-	+5 / +42.8	+118 / +244	8,9 - 1.82
Acetal	45500	3117	-	-	-43 / -45.4	+110 / +230	13,5 - 2.76

- Belt strength and temperature values are maximum on the table.

2 Inch - 50.8mm Modular Belt Series

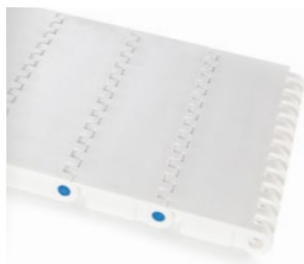

HP508 C



HP508 RR



HP508 FG
Battery Belt



HP508 Series *Accessories and Technical Specifications*



Z8

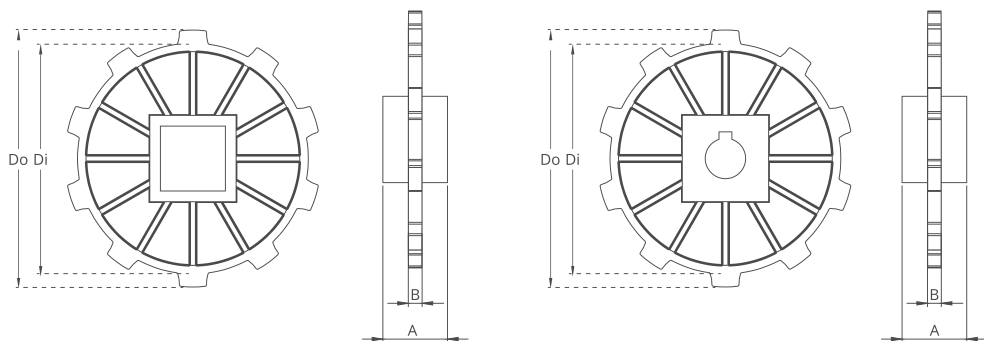

HP508 Series / Standard Sprockets Dimensions

NO. TEETH	Di mm/inch	Do mm/inch	B mm/inch	A mm/inch	Square Bore (Q) mm/inch	Round Bore (R) mm/inch	PRODUCT CODE	
							Square Type (Q)	Round Type (R)
Z8	109,0 / 4.29	125,0 / 4.92	9,0 / 0.35	40 / 1.57	40 / 1.5	25-30 / 1-1.25	HP508SQZ8*PA	HP508SRZ8*PA
Z10	142,0 / 5.59	159,0 / 6.22	9,0 / 0.35	40 / 1.57	40 / 1.5	25-30 / 1-1.25	HP508SQZ10*PA	HP508SRZ10*PA

*Other sprockets and hub sizes are manufactured up to request.

*POM (Acetal) and PP (Polypropylene) sprockets raw material is available on request.

***Machined Split Sprockets are available for each size.**

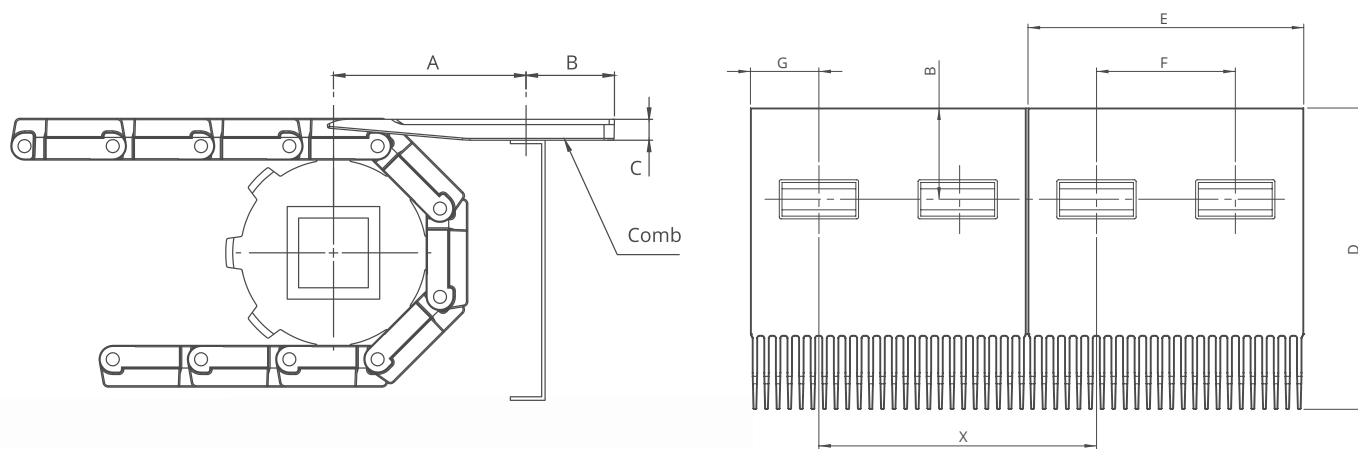

HP508 Series / Comb Technical Specifications

	inch	mm
A	3.94	100,0
B	1.97	50,0
C	0.47	12,0
D	6.50	165,0
E	5.94	151,0
F	2.99	76,0
G	1.48	37,5
X	5.98	152,0

EC254 R



MODUTECH

Pitch :	25,8 mm / 1 inch
Belt Surface :	Open, Smooth Surface
Minimum Width :	100 mm / 3.94 inch
Open Area (%) :	36%. (Biggest opening 7,5 x 12 mm)
Flight :	Yes. (T25, T50)
Side Wall :	Yes. (h=25 mm)
Rod :	Ø5 mm / 0.197 inch - Self Lock
Approved :	FDA and EU
Curve :	Yes
Color :	Additional colors available
Cleanability :	Excellent
Application :	Straight and side flexing
Collapse Factor :	2.1 - 2.4
Belt Thickness:	11 mm / 0.433 inch

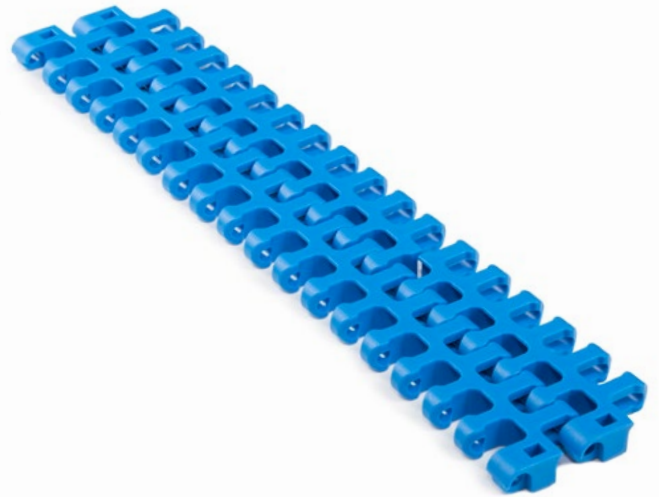

Product Features and Functional Benefits

- Available for light and medium load capacity.
- 180 degree high speed side flexing applications.
- High temperature and wear resistance.
- Unique locking system.
- Belt provides optimal open area for drainage and airflow.

Available Moulded Module Sizes

- 200 mm / **7.87 inch** module
- 100 mm / **3.94 inch** module

EC254 R / Technical Information

BELT MATERIAL	BELT STRENGTH				TEMPERATURE		BELT WEIGHT Kg/m ² - lb/ft ²
	Straight		Curve		°C (min.) - °F (min.)	°C (max.) - °F (max.)	
	N/m	lb/ft	N/m	lb/ft			
Polypropylene	20900	1430	1100	248	+5 / +42.8	+90 / +194	4,7 - 0.96
Polyethylene	-	-	-	-	-	-	-
Acetal	29700	2035	1650	372	-43 / -45.4	+110 / +230	7,0 - 1.44

- Belt strength and temperature values are maximum on the table.

EC254 R-GT

Pitch :	25,8 mm / 1 inch
Belt Surface :	Open, Friction Top Surface
Minimum Width :	100 mm / 3.94 inch
Open Area (%) :	36%. (Biggest opening 7.5 x 12 mm)
Flight :	Yes. (h=25 mm, h=50 mm)
Side Wall :	Yes. (h=25 mm)
Rod :	Ø5 mm / 0.197 inch - Self Lock
Approved :	FDA and EU
Curve :	Yes
Color :	Additional colors available
Cleanability :	Excellent
Application :	Straight and side flexing
Collapse Factor :	2.1 - 2.4
Belt Thickness:	15,5 mm / 0.61 inch

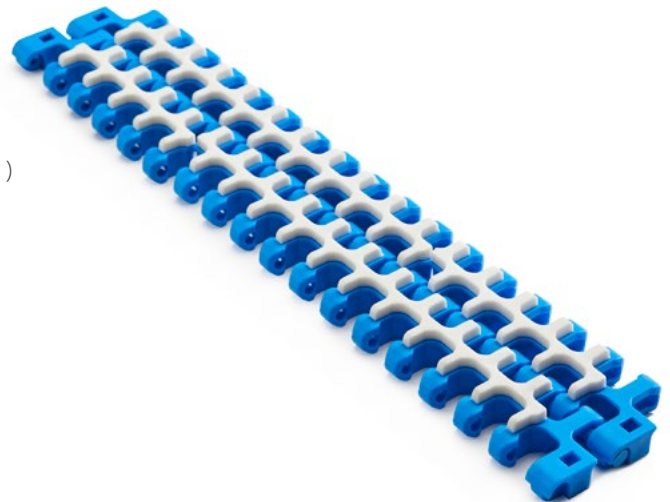

EC254 R Series *Accessories and Technical Specifications*



MODUTECH

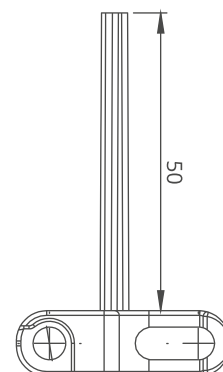
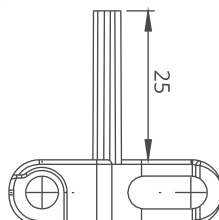

EC254 R Series / TAB - Technical Specification

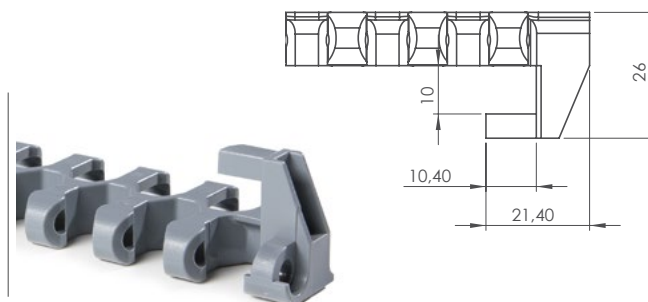
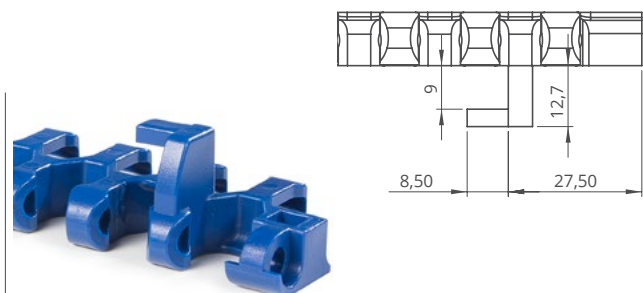

Z12

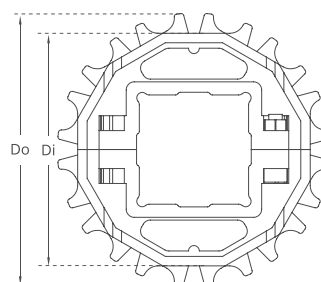
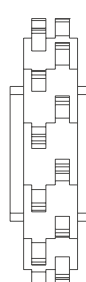
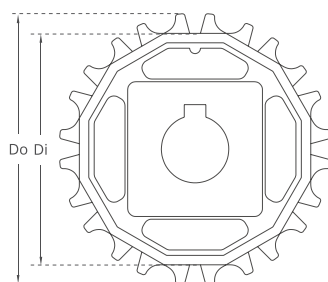

Split moulded sprockets are available.

EC254 R Series / Standard Sprockets Dimensions

NO. TEETH	Di mm/inch	Do mm/inch	B mm/inch	A mm/inch	Square Bore (Q) mm/inch	Round Bore (R) mm/inch	PRODUCT CODE	
							Square Type (Q)	Round Type (R)
Z8	52,0 / 2.05	67,0 / 2.64	6 / 0.24	30 / 1.18	25 / 1	25 / 1	MD-TR254SQ25Z8*POM	MD-TR254SRZ8*POM
Z10	69,0 / 2.72	84,0 / 3.31	6 / 0.24	30 / 1.18	40 / 1.5	25-30 / 1-1.25	MD-TR254SQ10*POM	MD-TR254SRZ10*POM
Z12	85,84 / 3.38	100,84 / 3.97	6 / 0.24	30 / 1.18	40 / 1.5	25-30 / 1-1.25	MD-TR254SQ12*POM	MD-TR254SRZ12*POM
Z15	110,8 / 4.36	125,8 / 4.95	6 / 0.24	30 / 1.18	40 / 1.5	25-30 / 1-1.25	MD-TR254SQ15*POM	MD-TR254SRZ15*POM
Z16	119,1 / 4.69	134,1 / 5.28	6 / 0.24	30 / 1.18	40 / 1.5	25-30 / 1-1.25	MD-TR254SQ16*POM	MD-TR254SRZ16*POM
Z18	135,63 / 5.34	150,58 / 5.93	6 / 0.24	30 / 1.18	40 / 1.5	25-30 / 1-1.25	MD-TR254SQ18*POM	MD-TR254SRZ18*POM

*Other sprockets and hub sizes are manufactured up to request. *PA (Polyamide) and PP (Polypropylene) sprockets raw material is available on request.

*Machined Split Sprockets are available for each size.

EC254T R (Tight Radius)



MODUTECH

Pitch :	26 mm / 1 inch
Belt Surface :	Open, Smooth Surface
Minimum Width :	167 mm / 6.57 inch
Open Area (%) :	38%. (Biggest opening 6,5 x 12 mm)
Flight :	No
Side Wall :	Yes (h=25 mm)
Rod :	Ø5 mm / 0.197 inch - Self Lock
Approved :	FDA and EU
Curve :	Yes
Color :	Additional colors available
Cleanability :	Excellent
Application :	Straight and side flexing
Collapse Factor :	1.4 - 1.6
Belt Thickness:	13 mm / 0.512 inch

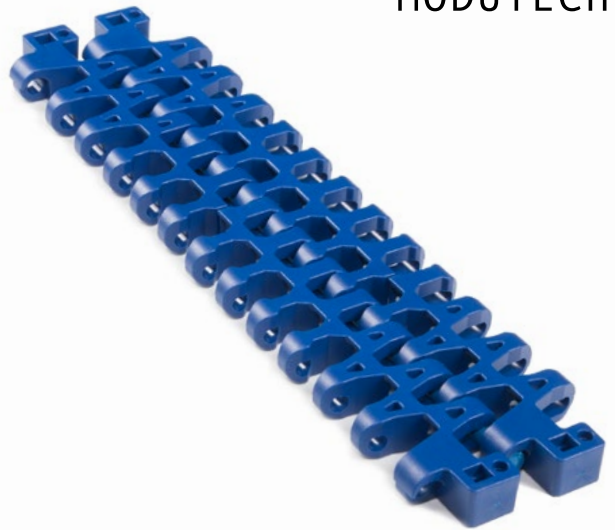

Product Features and Functional Benefits

- Belt designed for tight radius applications.
- Available for light and medium load capacity.
- 180 degree high speed side flexing applications.
- High temperature and wear resistance. Unique locking system.
- Belt provides optimal open area for drainage and airflow.

Available Moulded Module Sizes

- 200 mm / **7.87 inch** module
- 162 mm / **6.38 inch** module
- 137 mm / **5.39 inch** module
- 112 mm / **4.41 inch** module
- 100 mm / **3.94 inch** module
- 87 mm / **3.43 inch** module

EC254T R / Technical Information

BELT MATERIAL	BELT STRENGTH				TEMPERATURE		BELT WEIGHT
	Straight		Curve		°C (min.) - °F (min.)	°C (max.) - °F (max.)	Kg/m ² - lb/ft ²
	N/m	lb/ft	N/m	lb/ft			
Polypropylene	15400	1055	660	149	+5 / +42.8	+90 / +194	5,8 - 1.19
Polyethylene	-	-	-	-	-	-	-
Acetal	22000	1507	1210	272	-43 / -45.4	+110 / +230	8,4 - 1.72

- Belt strength and temperature values are maximum on the table.



EC254T R Series Accessories and Technical Specifications



MODUTECH

EC254T R Series / TAB - Technical Specification

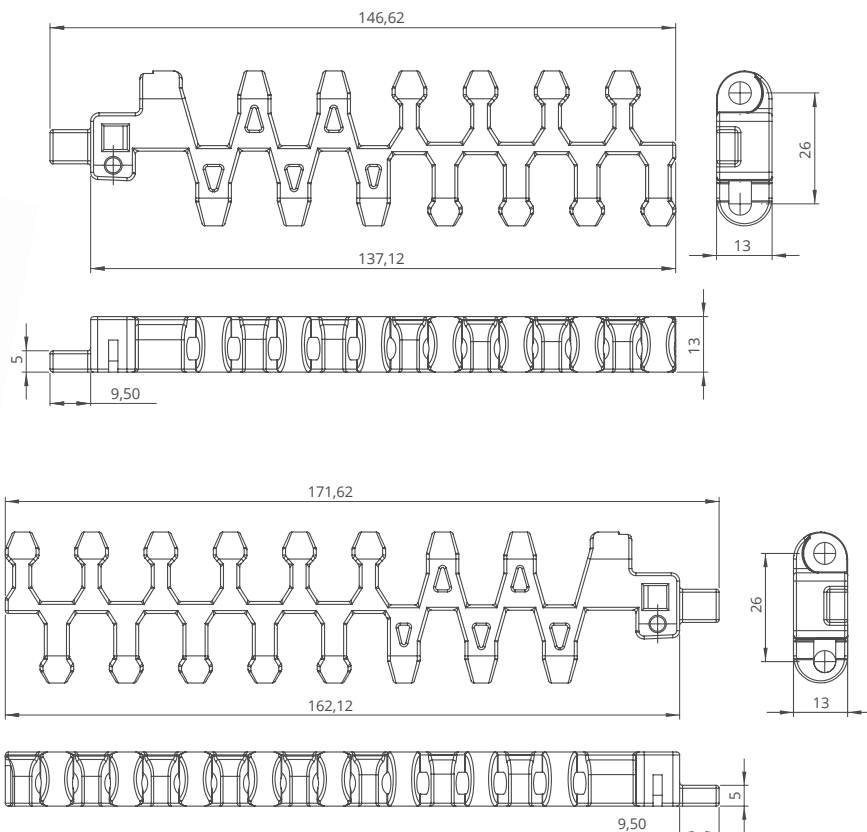

Z12

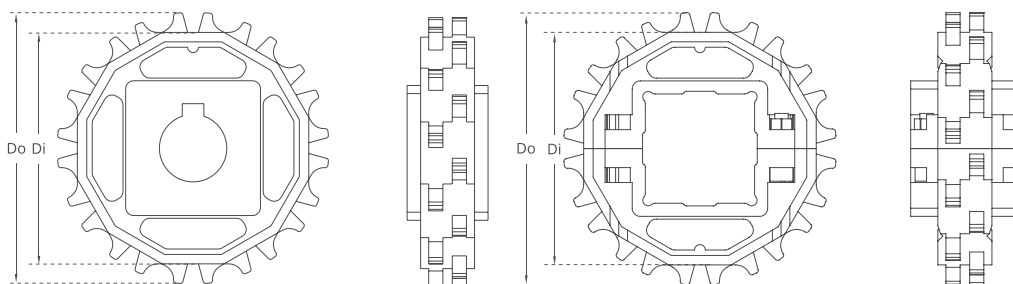

Split moulded sprockets are available.

EC254T R Series / Standard Sprockets Dimensions

NO.TEETH	Di mm/inch	Do mm/inch	B mm/inch	A mm/inch	Square Bore (Q) mm/inch	Round Bore (R) mm/inch	PRODUCT CODE	
							Square Type (Q)	Round Type (R)
Z8	52,0 / 2.05	67,0 / 2.64	6 / 0.24	30 / 1.18	25 / 1	25 / 1	MD-TR254SQ25Z8*POM	MD-TR254SRZ8*POM
Z10	69,0 / 2.72	84,0 / 3.31	6 / 0.24	30 / 1.18	40 / 1.5	25-30 / 1-1.25	MD-TR254SQZ10*POM	MD-TR254SRZ10*POM
Z12	85,84 / 3.38	100,84 / 3.97	6 / 0.24	30 / 1.18	40 / 1.5	25-30 / 1-1.25	MD-TR254SQZ12*POM	MD-TR254SRZ12*POM
Z15	110,8 / 4.36	125,8 / 4.95	6 / 0.24	30 / 1.18	40 / 1.5	25-30 / 1-1.25	MD-TR254SQZ15*POM	MD-TR254SRZ15*POM
Z16	119,1 / 4.69	134,1 / 5.28	6 / 0.24	30 / 1.18	40 / 1.5	25-30 / 1-1.25	MD-TR254SQZ16*POM	MD-TR254SRZ16*POM
Z18	135,63 / 5.34	150,58 / 5.93	6 / 0.24	30 / 1.18	40 / 1.5	25-30 / 1-1.25	MD-TR254SQZ18*POM	MD-TR254SRZ18*POM

*Other sprockets and hub sizes are manufactured up to request. *PA (Polyamide) and PP (Polypropylene) sprockets raw material is available on request.

*Machined Sprockets are available for each size.

Engineering Information

All Products

BELT CODE	Bakery	Meat	Poultry	Seafood	Fruit & Vegetables	Snackfood	Beverages & Bottling	Can Manufacturing	Tire Manufacturing	Automotive	Corrugated Cardboard	Packaging	Printing & Paper	Material Handling	Textile	Postal
MP80 C	*	*	*	*							*					
MP80 FG	*	*	*	*							*					
MP80 NS	*	*	*	*							*					
MP80 NP	*	*	*	*							*					
MD127 GAP%50	*			*	*									*		
HC127 C		*	*	*	*	*										
EC127 C	*	*	*	*	*	*	*	*	*	*	*	*	*	*		
EC127 FG	*	*		*	*	*	*	*		*	*	*	*	*		
EC127 GT	*	*	*	*	*	*	*	*			*	*	*	*		
XP254 C	*	*	*	*	*	*	*	*	*	*	*	*	*	*		
XP254 PR%22		*		*	*	*								*		
XP254 FG			*	*	*	*		*						*		
XP254 FLT CR						*	*		*	*	*		*		*	
XP254 CR						*				*			*		*	
EC254 C		*	*		*	*										
EC254 PR%16					*											
EC254 NT		*	*		*											
MD254 C	*	*	*	*	*	*	*	*			*	*	*	*		
MD254 FG	*	*	*	*	*	*	*	*	*		*		*	*	*	
MD254 RR				*		*	*				*		*			
MD254 GT	*	*	*	*	*	*	*				*		*	*		
MD254 GAP%48	*			*	*									*		
MD508 C					*	*		*	*						*	
MD508 FG					*	*										
MD508 PR%25					*	*										
EC508 C		*	*	*	*	*					*		*	*		
EC508 PR%22			*	*	*	*					*		*	*		
EC508 PR%11					*	*					*		*	*		
EC508 PR%13				*	*	*					*		*	*		
EC508 FG				*	*	*		*			*		*	*		
EC508 DT			*	*	*	*							*	*		
EC508 NT		*	*	*	*	*							*	*		
EC508 FG-NT		*	*	*	*	*							*	*		
HP508 C					*	*	*	*	*	*	*		*	*		
HP508 RR					*	*	*				*		*	*		
HP508 FG									*				*	*		
EC254 R	*	*	*	*	*	*	*	*	*	*	*	*	*	*	*	*
EC254T R (Tight Radius)	*	*	*	*	*	*	*	*	*	*	*	*	*	*	*	*

BELT RAW MATERIAL / PINS RAW MATERIAL COMBINATION

	Applications	Belt Modules	Rods Pins
Standart	General Use Dry General Use Wet Chemical Resistance Low Temperature Low Temperature High Load Dry	PP PP PP PE POM POM	PP - POM - PA or PBT POM - PP or PBT PP or PBT PE - POM or PBT PE - POM or PBT PA or PBT
High Temperature	High Load Dry Wet 55 to 108 °C Temperature up to 180 °C	POM PPH (special) PA	PA or PBT PPH (Special) / Steel or PBT PA / Steel or PBT
Abrasive Conditions	Dry Wet up to 55 °C	POM PP	PA or PBT POM or PBT

STANDARD BELT MATERIALS WITH MODUTECH CODE				
Material	Description	Code	Food Approved	Temperature
Polypropylene	- Standard material for the most common conveying applications . - Excellent chemical resistance.	PP	FDA - EU	+5 to +80 °C
Polyethylene	- Excellent chemical resistance . - Well suited for very low temperature with good impact resistance . - Not suitable for abrasive conditions.	PE	FDA - EU	-70 to +60 °C
Polyacetal	- Good strength and low coefficient of friction . - Not suitable for chemical environment. - Suitable for heavy duty applications.	POM	FDA - EU	Dry Conditions -38 to +90 °C Wet Conditions -35 to +60 °C

STANDARD BELT RAW MATERIALS WITH MODUTECH CODE				
Material	Description	Code	Food Approved	Temperature
Polyamide6	- High strength and abrasion resistance. - Suitable for heavy duty applications. - Not suitable for wet conditions.	PA6	FDA - EU	Dry Conditions -35 to +120 °C Wet Conditions Not Recommended
Polyamide6.6	- Better strength and abrasion resistance. - Suitable for heavy duty applications. - Not suitable for wet conditions.	PA6.6	FDA - EU	Dry Conditions -35 to +120 °C Wet Conditions Not Recommended
Antistatic Polyacetal	- Reduced electrical surface to reduce belt charge up and dust accumulation. - Suitable for heavy duty applications and low temperature.	POM	-	Dry Conditions -35 to +80 °C Wet Conditions Not Recommended
Detectable Polyacetal	- Polyacetal with a special additive, which makes the material very well detectable for X-ray and metal detectors.	POM	FDA - EU	Dry Conditions -38 to +90 °C
Detectable Polypropylene	- Polypropylene with a special additive, which makes the material very well detectable for X-ray and metal detectors.	PP	FDA - EU	+5 to +90 °C
Hot Water Resistant Polypropylene	- Polypropylene with a special additive to improved temperature resistance. - Suitable for wet conditions.	PPH	FDA - EU	+5 to +115 °C
Low Friction Acetal	- Better strength and low coefficient of friction. - Not suitable for chemical environment. - Suitable for heavy duty applications.	POM LF	FDA - EU	+5 to +108 °C
High Performance Acetal (PBT)	- Extra wear resistance, strength and, low coefficient of friction. - Not suitable for chemical environment. - Suitable for heavy duty applications.	POM HP	FDA - EU	-35 to +90 °C
Extra High Temperature (EHT)	- Excellent heat resistance. - Suitable for light-medium duty applications at elevated temperatures.	PA EHT	-	Dry Conditions +4 to +210 °C Wet Conditions No Request
Flame retardant Polypropylene	- Flame retardant thermoplastic material for low-flammability. - High impacts below 10 °C must be avoided.	PP FR	-	+5 to +105 °C
Electrically conductive Polyoxymethylene (Acetal)	- Low electrical surface and volume resistance. - Electrical surface resistivity (ps) below 50'000 Ohm/sq. - High strength and low coefficient of friction. - Suitable for heavy duty applications and low temperatures.	POM EC	-	Dry Conditions -40 to +93 °C Wet Conditions No Request
Impact and cut resistant Polyoxymethylene (Acetal)	- Advanced impact and cut resistant surface. - Suitable for meat cutting conveyors and high impact applications. - Good chemical resistance to oil and alkalines, but not suitable for long-term contact with high concentration of acids and chlorine.	POM ICR	FDA - EU	Dry Conditions -40 to +93 °C Wet Conditions -40 to +60 °C



MODUTECH®

- DECLARATION OF COMPLIANCE -

Modutech Konveyör Bant Sistemleri San. ve Tic. A.S., Kemalpaşa OSB Mah. No: 228 Kuyucak Yolu Kumeevleri / Izmir, Turkey, here by declares under its exclusive responsibility that the Modular Belt (PP) Conforms with the Food Regulation:

FDA

according to the CFR code
code of Federal Regulations

Title 21 § 177.520

Granules and additives used to manufacture the modular belts are selected exclusively among those listed by FDA standard Specifications 3.1 olefin copolymers for use in articles that contact food except for articles used for packing and holding food during cooking. This attest was issued on the basis of the accredited NSF laboratory test with:

Project no: 9896049,
Date of Report: January 9th, 2015



Modutech Konveyör Bant Sistemleri San. ve Tic. A.S.
Ankara Asfaltı 25 km Kızılcıklar Mevkii
Kuyucak Kemalpaşa / Izmir - TURKEY
Phone : +90 232 877 00 22 (pbx)
Fax: +90 232 877 01 11
Mail: info@modutech.com.tr
www.modutech.com.tr

İbrahim BAYIR
Modutech Quality Manager



MODUTECH®

- DECLARATION OF COMPLIANCE -

Modutech Konveyör Bant Sistemleri San. ve Tic. A.S., Kemalpaşa OSB Mah. No: 228 Kuyucak Yolu Kumeevleri / Izmir, Turkey, here by declares under its exclusive responsibility that the MODULAR BELT POLYPROPYLENE PLASTIC (PP) RAW MATERIAL

Conforms with the Food Regulations with reference to
COMMISSION REGULATION EU NO 10/2011 of 14 January 2011 and amendments

The belt is suitable to come into contact with any aqueous, acid, oily and fatty food listed in the Regulation EU 10/2011 and amendments.

As prescribed by Commission Regulation EU 10/2011 – Annex III and Annex V, MODUTECH declares that:

All materials used to produce this belt comply with the applicable law.

The overall migration of the authorised substances, measured using the prescribed extracting substances (simulants) is lower than the maximum limit allowed:

Overall migration with simulant A – ethanol 10%	< 10 mg / dm ²
Overall migration with simulant B – acetic acid 3%	< 10 mg / dm ²
Overall migration with simulant – ethanol 95%	< 10 mg / dm ²
Overall migration with simulant – isooctane	< 10 mg / dm ²
Overall migration with simulant E – MPPPO (tenax)	< 10 mg / dm ²

Tests have been carried out for a period of 2 hours at 70°C.
The limit of detection is 3 mg / dm².

The soluble heavy metals in aqueous test is lower than the maximum limit allowed :

Specific migration of Barium	< 1,00 mg / kg
Specific migration of Cobalt	< 0,05 mg / kg
Specific migration of Copper	< 5,00 mg / kg
Specific migration of Iron	< 48,00 mg / kg
Specific migration of Lithium	< 0,60 mg / kg
Specific migration of Manganese	< 0,60 mg / kg
Specific migration of Zinc	< 25,00 mg / kg

The information herein contained represents an extract from an analysis certification issued by a Accredited IAS laboratory test with: Report no TR1130211 Dated 07.06.2017



Modutech Konveyör Bant Sistemleri San. ve Tic. A.S.
Ankara Asfaltı 25 km Kızılcıklar Mevkii
Kuyucak Kemalpaşa / Izmir - TURKEY
Phone : +90 232 877 00 22 (pbx)
Fax: +90 232 877 01 11
Mail: info@modutech.com.tr
www.modutech.com.tr

İbrahim BAYIR
Modutech Quality Manager

Our Declaration of Compliance

Modutech offers you wide range of modular belts with FDA - EU certificates.

Movement Technologies



İZMİR Head Office

Kemalpaşa OSB Mahallesi
NİF Sanayi Caddesi No:5
Kemalpaşa / İZMİR - TÜRKİYE

Phone: +90 232 877 00 22 (pbx)
Fax: +90 232 877 01 11
e-mail: info@modutech.com.tr
www.modutech.com.tr

GERMANY Office

Modutech Belting GmbH
Konsul-Smidt-Straße 8b
28217 Bremen - GERMANY

Phone: +49 421 98699961
Fax: +49 174 1775388
e-mail: sales@modutech-belting.de
www.modutech-belting.de