

# TENSIONER DEVICES

## Optimum tension for chain and belt drives

- Quiet and smooth running
- Best possible transfer of power
- Automatic re-tensioning
- Compensation for belt elongation
- Pressing, guiding and vibration damping

### Product advantages:

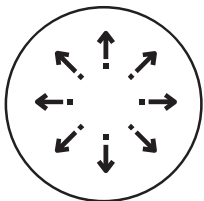

wide range  
of applications

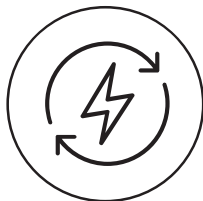

energy-saving

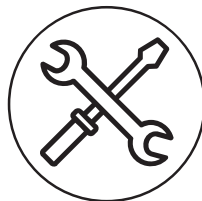

minimal  
maintenance costs

# Selection table tensioner devices

	Illustration	Type	Description	Page
Standard tensioner devices		SE	Standard component. Housing and inner part made out of steel. Rubber quality Rubmix 10. Steel parts ROSTA blue painted. Working temperature: – 40 ° to + 80 °C.	5.3
		SE-G	Oil resistant. Housing and inner part made out of steel. Rubber quality Rubmix 20. Steel parts galvanized. Marked with yellow dot. Working temperature: – 30 ° to + 90 °C.	
		SE-W	Heat resistant. Housing and inner part made out of steel. Rubber quality Rubmix 40. Steel parts ROSTA blue painted. Marked with red dot. Tension force 40% less than SE. Working temperature: – 35 ° to + 120 °C max.	
Additional tensioner devices		SE-R	Reinforced lever arm. Housing and inner part made out of steel. Rubber quality Rubmix 10. Arm and inner core especially welded for use on combustion engines and compressors. Steel parts ROSTA blue painted. Marked with white ring. Working temperature: – 40 ° to + 80 °C.	5.3
		SE-I	Housing and inner part made out of stainless steel. Rubber quality Rubmix 10. For the use in food- and pharmaceutical industries. Material: GX5CrNi19-10. Working temperature: – 40 ° to + 80 °C.	5.4
		SE-B	Boomerang®, Housing and inner part made out of steel. Rubber quality Rubmix 10. For the tensioning of very long chain and belt drives (triple compensation). Steel parts ROSTA blue painted. Working temperature: – 40 ° to + 80 °C.	5.5
		SE-F	Front mounting device. Housing and inner part made out of steel. Rubber quality Rubmix 10. As example for installations on blind-hole frames (fixation from the front only). Steel parts ROSTA blue painted. Hex socket screw quality 12.9. Working temperature: – 40 ° to + 80 °C.	5.6
		SE-FE	Front mounting. For installations on blind-hole frames (fixation from the front only). Steel parts painted black. Hex socket screw quality 12.9. Especially designed for engine applications. Working temperature: see page 5.7.	5.7

Note about accessories on pages 5.8–5.15.

# Tensioner Device

## SE/SE-G/SE-W/SE-R

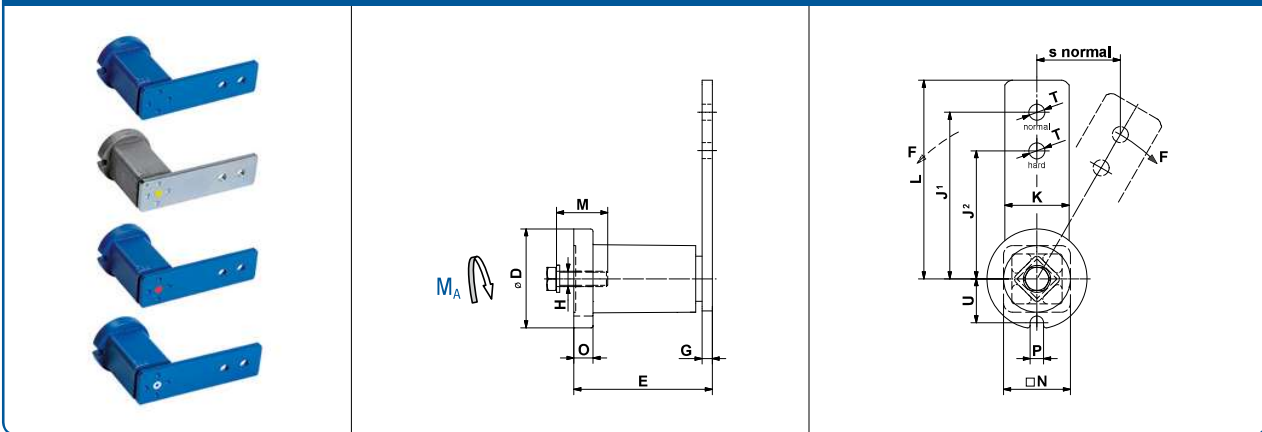

Part no.	Type	D	E	G	H	J <sup>1</sup>	J <sup>2</sup>	K	L	M	N	O	P	T	U	Weight [kg]
06 011 001	SE 11	35	51 <sup>+1</sup> <sub>-0.5</sub>	5	M6	80	60	20	90	20	22	6	8	8.5	16.5	0.2
06 013 201	SE 11-G	35	51 <sup>+1</sup> <sub>-0.5</sub>	5	M6	80	60	20	90	20	22	6	8	8.5	16.5	0.2
06 011 002	SE 15	45	64 <sup>+1</sup> <sub>-0.5</sub>	5	M8	100	80	25	112.5	25	30	8	8.5	10.5	20.8	0.4
06 013 202	SE 15-G	45	64 <sup>+1</sup> <sub>-0.5</sub>	5	M8	100	80	25	112.5	25	30	8	8.5	10.5	20.8	0.4
06 015 002	SE 15-W	45	64 <sup>+1</sup> <sub>-0.5</sub>	5	M8	100	80	25	112.5	25	30	8	8.5	10.5	20.8	0.4
06 011 702	SE-R 15	45	64 <sup>+1</sup> <sub>-0.5</sub>	5	M8	100	80	25	112.5	25	30	8	8.5	10.5	20.8	0.4
06 011 003	SE 18	58	79 <sup>+1</sup> <sub>-0.5</sub>	7	M10	100	80	30	115	30	35	10.5	8.5	10.5	25.3	0.7
06 013 203	SE 18-G	58	79 <sup>+1</sup> <sub>-0.5</sub>	7	M10	100	80	30	115	30	35	10.5	8.5	10.5	25.3	0.7
06 015 003	SE 18-W	58	79 <sup>+1</sup> <sub>-0.5</sub>	7	M10	100	80	30	115	30	35	10.5	8.5	10.5	25.3	0.7
06 011 703	SE-R 18	58	79 <sup>+1.5</sup> <sub>-0.5</sub>	7	M10	100	80	30	115	30	35	10.5	8.5	10.5	25.3	0.7
06 011 004	SE 27	78	108 <sup>+1.5</sup> <sub>-0.5</sub>	8	M12	130	100	50	155	40	52	15	10.5	12.5	34.3	1.8
06 013 204	SE 27-G	78	108 <sup>+1.5</sup> <sub>-0.5</sub>	8	M12	130	100	50	155	40	52	15	10.5	12.5	34.3	1.9
06 015 004	SE 27-W	78	108 <sup>+1.5</sup> <sub>-0.5</sub>	8	M12	130	100	50	155	40	52	15	10.5	12.5	34.3	1.8
06 011 005	SE 38	95	140 <sup>+2</sup> <sub>-0.5</sub>	10	M16	175	140	60	205	40	66	15	12.5	20.5	42.0	3.3
06 013 205	SE 38-G	95	140 <sup>+2</sup> <sub>-0.5</sub>	10	M16	175	140	60	205	40	66	15	12.5	20.5	42.0	3.3
06 015 005	SE 38-W	95	140 <sup>+2</sup> <sub>-0.5</sub>	10	M16	175	140	60	205	40	66	15	12.5	20.5	42.0	3.3
06 011 006	SE 45	115	200 <sup>+2</sup> <sub>-1</sub>	12	M20	225	180	70	260	50	80	18	12.5	20.5	52.0	6.4
06 013 206	SE 45-G	115	200 <sup>+2</sup> <sub>-1</sub>	12	M20	225	180	70	260	50	80	18	12.5	20.5	52.0	6.5
06 015 006	SE 45-W	115	200 <sup>+2</sup> <sub>-1</sub>	12	M20	225	180	70	260	50	80	18	12.5	20.5	52.0	6.4
06 011 007	SE 50	130	210 <sup>+3</sup> <sub>-1</sub>	20	M24	250	200	80	290	60	87	20	17	20.5	57.5	10.4
06 013 207	SE 50-G	130	210 <sup>+3</sup> <sub>-1</sub>	20	M24	250	200	80	290	60	87	20	17	20.5	57.5	10.3
06 015 007	SE 50-W	130	210 <sup>+3</sup> <sub>-1</sub>	20	M24	250	200	80	290	60	87	20	17	20.5	57.5	10.3

Further product and performance data in chapter 7 «Technology».

SE-R: Tensioning element with strengthened tensioning arm

If no other units are specified, the numbers given are in mm.

# Tensioner Device

## SE-I

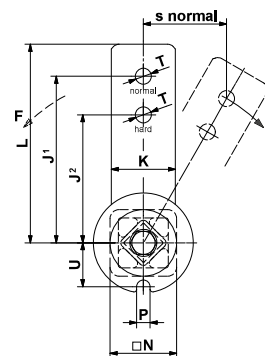
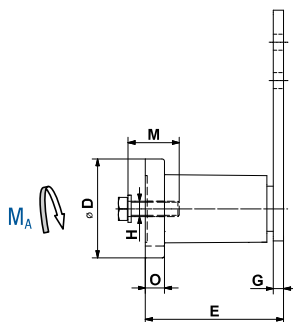

Part no.	Type	D	E	G	H	J <sup>1</sup>	J <sup>2</sup>	K	L	M	N	O	P	T	U	Weight [kg]
06 071 111	<b>SE-I 15</b>	45	64 <sup>+1</sup> <sub>-0.5</sub>	5	M8	100	80	25	112.5	25	30	8	8.5	10.5	20.8	0.4
06 071 112	<b>SE-I 18</b>	58	79 <sup>+1.5</sup> <sub>-0.5</sub>	7	M10	100	80	30	115	30	35	10.5	8.5	10.5	25.3	0.8
06 071 113	<b>SE-I 27</b>	78	108 <sup>+2</sup> <sub>-0.5</sub>	8	M12	130	100	50	155	40	52	15	10.5	12.5	34.3	2.3
06 071 114	<b>SE-I 38</b>	95	140 <sup>+2</sup> <sub>-0.5</sub>	10	M16	175	140	60	205	40	66	15	12.5	20.5	42.0	4.1

Further product and performance data in chapter 7 «Technology».

Tensioning element made out of stainless steel, INOX

If no other units are specified, the numbers given are in mm.

# Tensioner Device

## SE-B Boomerang®

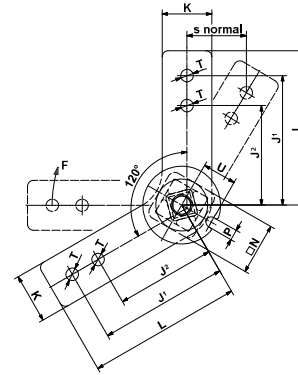
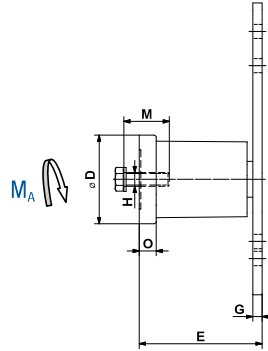

Part no.	Type	D	E	G	H	J <sup>1</sup>	J <sup>2</sup>	K	L	M	N	O	P	T	U	Weight [kg]
06 021 003	<b>SE-B 18</b>	58	78 <sup>+1,5</sup> <sub>-0,5</sub>	6	M10	100	80	30	115	30	35	10.5	8.5	10.5	25.3	0.8
06 021 004	<b>SE-B 27</b>	78	108 <sup>+2</sup> <sub>-0,5</sub>	8	M12	130	100	50	155	40	52	15	10.5	12.5	34.3	2.2

Further product and performance data in chapter 7 «Technology».  
If no other units are specified, the numbers given are in mm.

# Tensioner Device

## SE-F

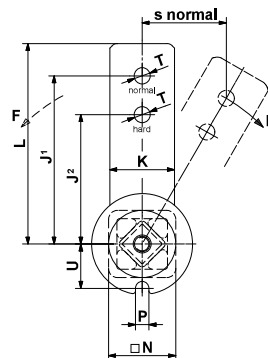
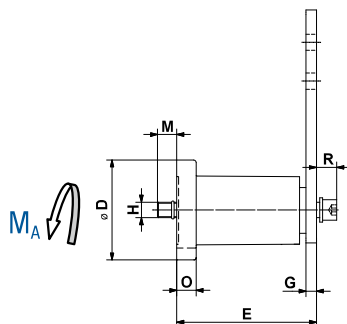

Part no.	Type	D	E	G	H	J <sup>1</sup>	J <sup>2</sup>	K	L	M	N	O	P	R	T	U	Weight [kg]
06 061 002	<b>SE-F 15</b>	45	64 <sup>+1</sup> <sub>-0.5</sub>	5	M6	100	80	25	112.5	12	30	8	8.5	10	10.5	20.8	0.4
06 061 003	<b>SE-F 18</b>	58	79 <sup>+1.5</sup> <sub>-0.5</sub>	7	M8	100	80	30	115	18	35	10.5	8.5	11	10.5	25.3	0.7
06 061 004	<b>SE-F 27</b>	78	108 <sup>+2</sup> <sub>-0.5</sub>	8	M10	130	100	50	155	17	52	15	10.5	15	12.5	34.3	1.9
06 061 005	<b>SE-F 38</b>	95	140 <sup>+2</sup> <sub>-0.5</sub>	10	M12	175	140	60	205	16	66	15	12.5	17	20.5	42.0	3.5
06 061 006	<b>SE-F 45</b>	115	200 <sup>+3</sup> <sub>-1</sub>	12	M16	225	180	70	260	32	80	18	12.5	24	20.5	52.0	7.2
06 061 007	<b>SE-F 50</b>	130	210 <sup>+3</sup> <sub>-1</sub>	20	M20	250	200	80	290	23	87	20	17	27	20.5	57.5	11.6

Further product and performance data in chapter 7 «Technology».

Tensioning element with front mounting.

Screw quality 12.9

If no other units are specified, the numbers given are in mm.

# Tensioner Device

## SE-FE

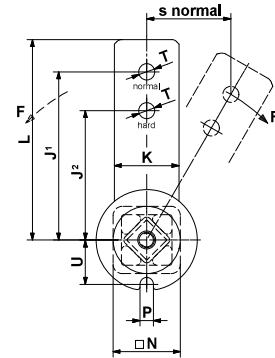
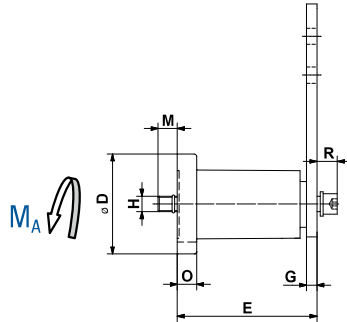

Part no.	Type	D	E	G	H	J <sup>1</sup>	J <sup>2</sup>	K	L	M	N	O	P	R	T	U	Weight [kg]
06 093 904	<b>SE-FE 27</b>	78	110 <sup>+2</sup> <sub>-0,5</sub>	10	M10	130	100	50	155	16	52	15	10.5	15	12.5	34.3	2.1
06 095 905	<b>SE-FE 38</b>	95	120 <sup>+2</sup> <sub>-0,5</sub>	10	M12	145	110	60	175	35	66	15	12.5	17	22.0	42.0	3.1

Part no.	Type	Rubber type	Working temperature	Marked with	Pre-tension $\sphericalangle$ 10° (J <sup>1</sup> )		Pre-tension $\sphericalangle$ 20° (J <sup>1</sup> )		Pre-tension $\sphericalangle$ 30° (J <sup>1</sup> )		Coating
					F [N]	s [mm]	F [N]	s [mm]	F [N]	s [mm]	
06 093 904	<b>SE-FE 27</b>	Rubmix 20	-30° to +90°C	yellow dot	150	23	380	44	810	65	RAL 9005 (black)
06 095 905	<b>SE-FE 38</b>	Rubmix 40	-35° to +120°C	red dot	170	25	425	50	870	73	RAL 9005 (black)

Further product and performance data in chapter 7 «Technology».

Tensioning element with front mounting in special design.

Screw quality 12.9

If no other units are specified, the numbers given are in mm.

# Tensioner Device

## Sprocket wheel set N

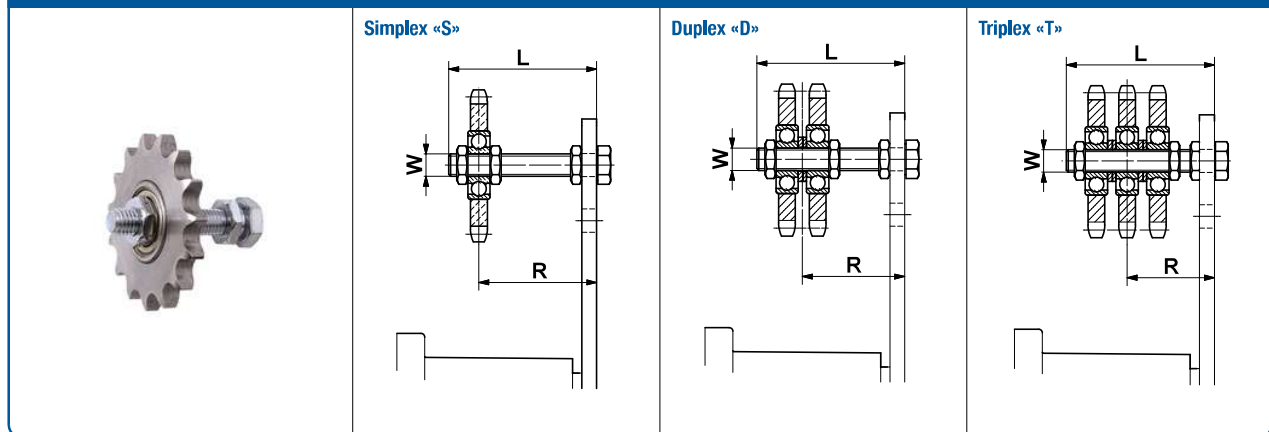

Part no.	Type	Roller chain		Number of teeth	W	L	Torque hex nut 0.5 d [Nm]	suitable for size SE	Adjusting range R with SE	Weight [kg]
		ANSI	DIN 8187							
<b>Simplex «S»</b>										
06 510 001	N $\frac{3}{8}$ "-10 S	35	ISO 06 B-1	15	M10	55	20	15/18	22-43/23-43	0.15
06 510 002	N $\frac{1}{2}$ "-10 S	40	ISO 08 B-1	15	M10	55	20	18	23-44	0.20
06 510 003	N $\frac{5}{8}$ "-12 S	50	ISO 10 B-1	15	M12	80	35	27	27-65	0.35
06 510 004	N $\frac{3}{4}$ "-12 S	60	ISO 12 B-1	15	M12	80	35	27	27-65	0.55
06 510 005	N $\frac{1}{2}$ "-20 S	60	ISO 12 B-1	15	M20	100	165	38	40-80	0.85
06 510 006	N1"-20 S	80	ISO 16 B-1	13	M20	100	165	38	40-80	1.25
06 510 007	N1 $\frac{1}{4}$ "-20 S	100	ISO 20 B-1	13	M20	100	165	45/50	40-80/48-80	2.00
06 510 008	N1 $\frac{1}{2}$ "-20 S	120	ISO 24 B-1	11	M20	140	165	45/50	40-120/48-120	2.35
<b>Duplex «D»</b>										
06 520 001	N $\frac{3}{8}$ "-10 D	35	ISO 06 B-2	15	M10	55	20	15/18	27-39/28-39	2.00
06 520 002	N $\frac{1}{2}$ "-10 D	40	ISO 08 B-2	15	M10	55	20	18	30-37	0.35
06 520 003	N $\frac{5}{8}$ "-12 D	50	ISO 10 B-2	15	M12	80	35	27	36-57	0.60
06 520 004	N $\frac{3}{4}$ "-12 D	60	ISO 12 B-2	15	M12	80	35	27	37-56	1.05
06 520 005	N $\frac{1}{2}$ "-20 D	60	ISO 12 B-2	15	M20	120	165	38	50-90	1.35
06 520 006	N1"-20 D	80	ISO 16 B-2	13	M20	120	165	38	55-84	2.10
06 520 007	N1 $\frac{1}{4}$ "-20 D	100	ISO 20 B-2	13	M20	140	165	45/50	60-102/68-102	3.60
06 520 008	N1 $\frac{1}{2}$ "-20 D	120	ISO 24 B-2	11	M20	140	165	45/50	65-97/73-97	4.25
<b>Triplex «T»</b>										
06 530 001	N $\frac{3}{8}$ "-10 T	35	ISO 06 B-3	15	M10	70	20	18	33-48	0.25
06 530 002	N $\frac{1}{2}$ "-12 T	40	ISO 08 B-3	15	M12	80	35	27	41-51	0.50
06 530 003	N $\frac{5}{8}$ "-12 T	50	ISO 10 B-3	15	M12	80	35	27	43-50	0.95
06 530 004	N $\frac{3}{4}$ "-20 T	50	ISO 10 B-3	15	M20	120	165	38	56-84	1.25
06 530 005	N $\frac{1}{2}$ "-20 T	60	ISO 12 B-3	15	M20	120	165	38	59-80	1.50
06 530 006	N1"-20 T	80	ISO 16 B-3	13	M20	160	165	45	74-108	2.90
06 530 007	N1 $\frac{1}{4}$ "-20 T	100	ISO 20 B-3	13	M20	160	165	45/50	78-105/86-105	5.20
06 530 008	N1 $\frac{1}{2}$ "-20 T	120	ISO 24 B-3	11	M20	180	165	45/50	90-111/98-111	6.20

Allows accurate positioning of relevant chain track.  
 Ball-bearings 2Z/C3, permanently lubricated.  
 Working temperature: -40° bis +100°C.  
 If no other units are specified, the numbers given are in mm.



# Tensioner Device

## Sprocket wheel N

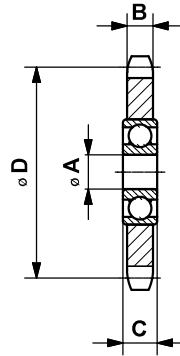

Part no.	Type	Roller chain		Number of teeth	A	B	C	D	Weight [kg]
		ANSI	DIN 8187						
06 500 001	N $\frac{3}{8}$ "-10	35	ISO 06 B	15	10	5.3	9	45.81	0.06
06 500 002	N $\frac{1}{2}$ "-10	40	ISO 08 B	15	10	7.2	9	61.08	0.15
06 500 003	N $\frac{1}{2}$ "-12	40	ISO 08 B	15	12	7.2	12	61.08	0.15
06 500 004	N $\frac{5}{8}$ "-12	50	ISO 10 B	15	12	9.1	12	76.36	0.27
06 500 005	N $\frac{5}{8}$ "-20	50	ISO 10 B	15	20	9.1	15	76.36	0.29
06 500 006	N $\frac{3}{4}$ "-12	60	ISO 12 B	15	12	11.1	12	91.63	0.47
06 500 007	N $\frac{3}{4}$ "-20	60	ISO 12 B	15	20	11.1	15	91.63	0.47
06 500 008	N1"-20	80	ISO 16 B	13	20	16.1	15	106.14	0.88
06 500 009	N1 $\frac{1}{4}$ "-20	100	ISO 20 B	13	20	18.5	15	132.67	1.60
06 500 010	N1 $\frac{1}{2}$ "-20	120	ISO 24 B	11	20	24.1	15	135.23	1.93

Allows accurate positioning of relevant chain track.  
 Ball-bearings 2Z/ C3, permanently lubricated.  
 Working temperature: -40 ° bis + 100 °C.  
 If no other units are specified, the numbers given are in mm.

# Tensioner Device

## Chain rider set P

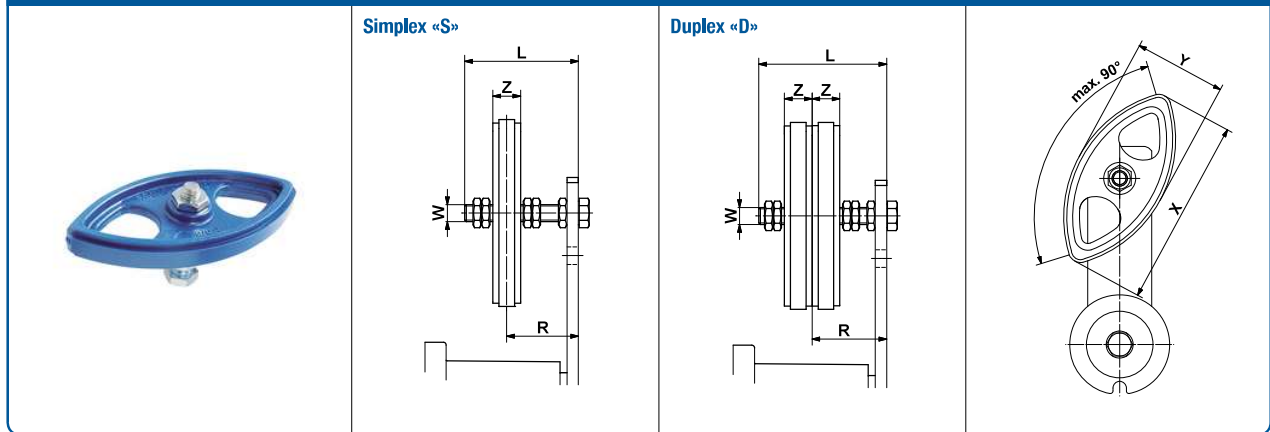

Part no.	Type	Roller chain		W	L	X	Y	Z	Torque hex nut 0.5 d [Nm]	suitable for size SE	Adjusting range R with SE	Weight [kg]
		ANSI	DIN 8187									
<b>Simplex «S»</b>												
06 550 001	<b>P<math>\frac{3}{8}</math>"-8 S</b>	35	ISO 06 B-1	M8	45	74	37	10.2	11	11	19-34	0.05
06 550 002	<b>P<math>\frac{1}{2}</math>"-10 S</b>	40	ISO 08 B-1	M10	55	96	48	13.9	20	15/18	23-41	0.10
06 550 003	<b>P<math>\frac{5}{8}</math>"-10 S</b>	50	ISO 10 B-1	M10	55	126	63	16.6	20	18	24-39	0.12
06 550 004	<b>P<math>\frac{3}{4}</math>"-12 S</b>	60	ISO 12 B-1	M12	80	148	72	19.5	35	27	30-61	0.18
<b>Duplex «D»</b>												
06 560 001	<b>P<math>\frac{3}{8}</math>"-8 D</b>	35	ISO 06 B-2	M8	45	74	37	10.2	11	11	25-30	0.07
06 560 002	<b>P<math>\frac{1}{2}</math>"-10 D</b>	40	ISO 08 B-2	M10	55	96	48	13.9	20	15/18	30-34	0.12
06 560 003	<b>P<math>\frac{5}{8}</math>"-10 D</b>	50	ISO 10 B-2	M10	70	126	63	16.6	20	18	34-46	0.17
06 560 004	<b>P<math>\frac{3}{4}</math>"-12 D</b>	60	ISO 12 B-2	M12	80	148	72	19.5	35	27	40-52	0.26

For double sided use. Max. allowed chain speed 1.5 m/sec.  
 Material: POM-H.  
 Working temperature: -40° bis +100°C.  
 If no other units are specified, the numbers given are in mm.

# Tensioner Device

## Chain rider P

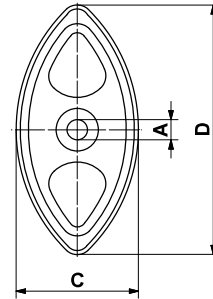

Part no.	Type	Roller chain		A	B	C	D	Weight [kg]
		ANSI	DIN 8187					
06 540 001	P $\frac{3}{8}$ "	35	ISO 06 B	8 <sup>+0,2</sup> <sub>0</sub>	10.2	37	74	0.02
06 540 002	P $\frac{1}{2}$ "	40	ISO 08 B	10 <sup>+0,2</sup> <sub>0</sub>	13.9	48	96	0.03
06 540 003	P $\frac{5}{8}$ "	50	ISO 10 B	10 <sup>+0,2</sup> <sub>0</sub>	16.6	63	126	0.05
06 540 004	P $\frac{3}{4}$ "	60	ISO 12 B	12 <sup>+0,2</sup> <sub>0</sub>	19.5	72	148	0.07

For double sided use. Max. allowed chain speed 1.5 m/sec.

Material: POM-H.

Working temperature: -40° bis + 100 °C.

If no other units are specified, the numbers given are in mm.

# Tensioner Device

## Tensioning roller standard R

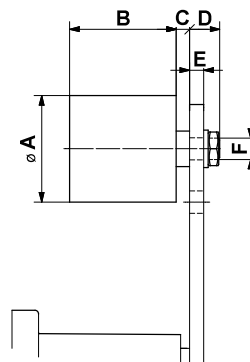

Part no.	Type	Max. speed [ rpm ]	Max. belt width	A	B	C	D	E	F	Torque hex nut 0.5 d [Nm]	suitable for size SE	Weight [kg]
06 580 001	<b>R 11</b>	8 000	30	30	35	2	14	≤5	M8	25	11	0.08
06 580 002	<b>R 15/18</b>	8 000	40	40	45	6	16	≤7	M10	20	15/18	0.17
06 580 003	<b>R 27</b>	6 000	55	60	60	8	17	≤8	M12	35	27	0.40
06 580 004	<b>R 38</b>	5 000	85	80	90	8	25	≤10	M20	165	38	1.15
06 580 005	<b>R 45</b>	4 500	130	90	135	10	27	≤12	M20	165	45	1.75

Customer-specific  $\varnothing A$  or outer contours on request.

Material: PA 6. Ball-bearings 2Z/C3, permanently lubricated.

Working temperature:  $-35^{\circ}$  bis  $+100^{\circ}\text{C}$ .

If no other units are specified, the numbers given are in mm.

# Tensioner Device

## Tensioning roller light RL

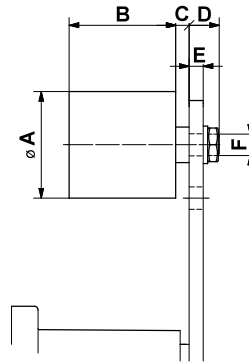

Part no.	Type	Max. speed [ rpm ]	Max. belt width	A	B	C	D	E	F	Torque hex nut 0.5 d [Nm]	suitable for size SE	Weight [kg]
06 580 901	<b>RL 11</b>	6 000	30	30	35	3	19	≤10	M8	25	11	0.08
06 580 902	<b>RL 15/18</b>	6 000	40	40	45	6	21	≤9	M10	49	15/18	0.17
06 580 903	<b>RL 27</b>	4 500	55	60	60	8	22	≤8	M12	86	27	0.50

Designed for light belt drive loads.

Material: PA 6. Ball-bearings 2Z/C3, permanently lubricated.

Working temperature: -35° bis +80°C.

If no other units are specified, the numbers given are in mm.

# Tensioner Device

## Bracket WS

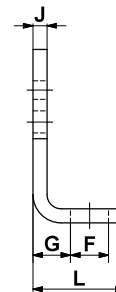
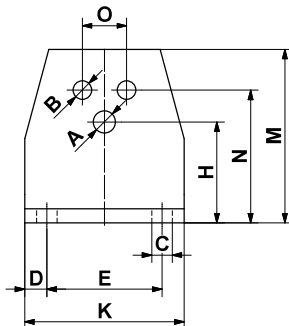

Part no.	Type	A	B	C	D	E	F	G	H	J	K	L	M	N	O	suitable for size SE	Weight [kg]
06 590 001	<b>WS 11</b>	6.5	5.5	7	7.5	30	13	11.5	27	4	45	30	46	35	10	11	0.08
06 590 002	<b>WS 15</b>	8.5	6.5	7	7.5	40	13	13.5	34	5	55	32	58	44	12	15	0.15
06 590 003	<b>WS 18</b>	10.5	8.5	9.5	10	50	15.5	16.5	43	6	70	38	74	55	20	18	0.28
06 590 004	<b>WS 27</b>	12.5	10.5	11.5	12.5	65	21.5	21	57	8	90	52	98	75	25	27	0.70
06 590 005	<b>WS 38</b>	16.5	12.5	14	15	80	24	21	66	8	110	55	116	85	35	38	0.90
06 590 006	<b>WS 45</b>	20.5	12.5	18	20	100	30	26	80	10	140	66	140	110	40	45	1.80

For the easy mounting of tensioners on the standard support (except SE 50).  
If no other units are specified, the numbers given are in mm.

# Tensioner Device

## Safety Sockets

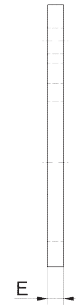
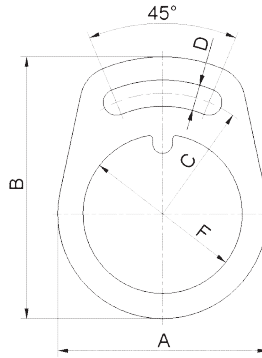

Part no.	Type	A	B	C	D	E	F	suitable for size SE	Weight [kg]
06 618 400	<b>SS 27</b>	104	130	60	13	8	79	27	0.35
06 618 394	<b>SS 38</b>	128	161	75	17	10	96.5	38	0.65

In case of uneven surfaces or coatings that give inadequate frictional locking, additional tensioning can be made with this safety clamp. If no other units are specified, the numbers given are in mm.

# Tensioner devices

## Tensioner device

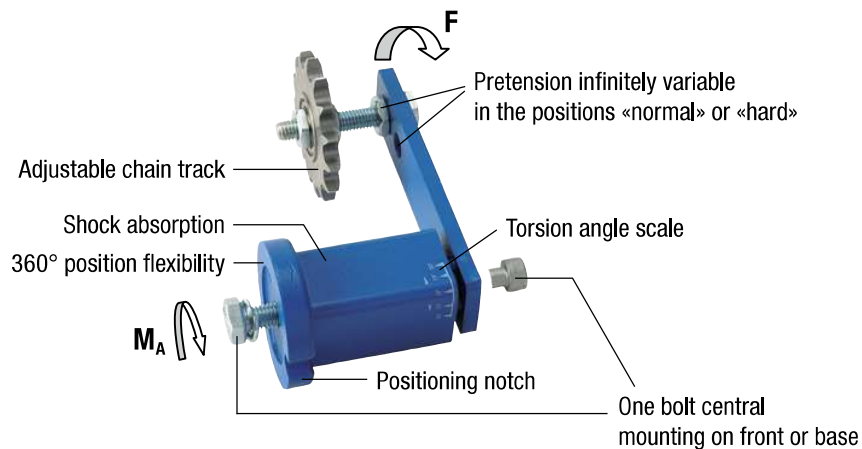

## Tensioning force F

Tensioning forces for lever position «normal» for SE / SE-G / SE-R / SE-R / SE-I

Size SE	Pre-tension $\leq 10^\circ$		Pre-tension $\leq 20^\circ$		Pre-tension $\leq 30^\circ$	
	F [N]	s [mm]	F [N]	s [mm]	F [N]	s [mm]
11	18	14	48	27	96	40
15	25	17	65	34	135	50
18	75	17	185	34	350	50
27	150	23	380	44	810	65
38	280	30	720	60	1500	88
45	520	39	1350	77	2650	113
50	740	43	2150	86	4200	125

The tensioning force can be continuously adjusted. The max. pre-tensioning angle is  $30^\circ$  out of neutral position.

When fixing the sprockets, riders and rollers in arm-position «hard», tensioning force will increase on about 25%.

SE-W: 40% lower tensioning force than standard versions (Rubmix 40).  
SE-FE: see SE-FE in chapter 5.

## Tightening torque $M_A$

	Quality 8.8	Quality 12.9 for SE-F/SE-FE
M6	10 Nm	17 Nm
M8	25 Nm	41 Nm
M10	49 Nm	83 Nm
M12	86 Nm	145 Nm
M16	210 Nm	355 Nm
M20	410 Nm	690 Nm
M24	750 Nm	

Table mentioning the tightening torque for the central screw (included in scope of delivery).



# Tensioner devices

## Installation guidelines

### «Z» layout

If chain tensioning wheels / chain sliders or tension rollers are mounted on the outer lever side, the distance «Z» should be as low as possible. The maximum pre-tensioning force  $F$  should not exceed 50% (~20° pre-tensioning).



### Use of SE-B Boomerang® tensioners

In very long chain and belt drives it was recommendable to install on the slack-side several tensioners, in order to compensate occurring elongation. The «Boomerang» with its bent double-arm equipped with two chain sprockets or a combination of grooved pulley and flat-roller (belt-drives) offers a triple-compensation of chain and belt elongations, due to S-shape contact-arc.

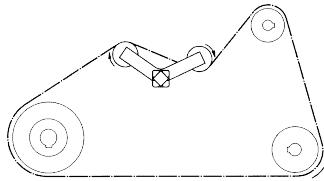

### Assembly

The central screw is tightened slightly. The tensioner housing is set with a wrench and tightened in the desired direction. Then tighten the screw with the appropriate  $M_A$  tightening torque. Position the wrench near the flange bottom.

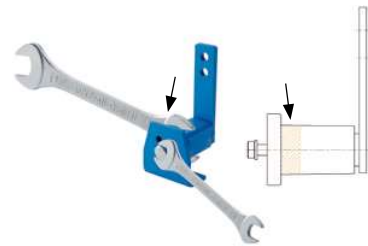

### Chain or belt drives

Further assembly instructions specific for chain or belt drives on the following pages.

## Installation guidelines for chain drives

### Standard positioning

The ROSTA tensioning device should be placed on the slack-side of the chain drive, close by the smaller sprocket wheel in order to enlarge its contact-arc, therefore contact application from outer side of drive. In mounted position the tensioner-arm should stay close to parallel to the chain run, in drain direction. By extremely long chain drives it is recommendable to install several tensioners or the type «Boomerang®» in order to enlarge the slack compensation.

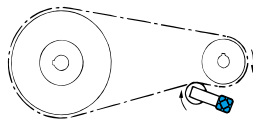

### Reversible chain drive

On reversing chain drives, we recommend installing two chain tensioners, one per chain strand. Due to the constantly alternating slackening, depending on the direction of travel of the drive, both tensioners should only be pre-tensioned to a maximum of 20° to retain a free return angle of 10° when changing from the «slack section» to the «working section».

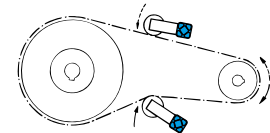

### Sprocket teeth engaged

When tightening for the first time, at least 3 teeth of the sprocket must be engaged with the chain. The free length of the chain between tensioning wheel and the next sprocket should be at least 4 sections.

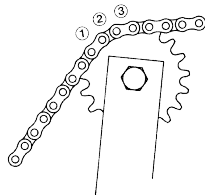

### Chain track

The tensioner sprocket and the chain sliders should be positioned on the track between 2 nuts «C». The chain track can be precisely set by adjusting the setting range R. The lock nut «B» is always tight.

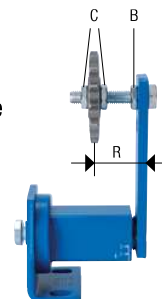

# Tensioner devices

## Installation guidelines for belt drives

### 1. Layout in belt drives

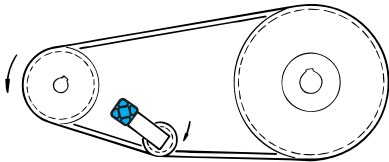

#### Tensioning from inside the belt drive with a V-belt pulley

- When installing in the slack section, both belt pulleys must have sufficient wrap angles (driver and driven).
- For vibration-intensive drives with very long centre distances, it is recommended use deep-grooved pulleys.

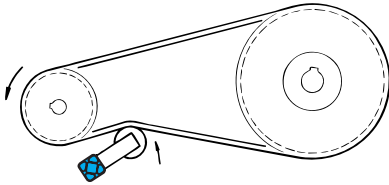

#### Tensioning with flat roller on the back of the belt

- Roll diameter should be at least  $\frac{2}{3}$  of the diameter of the smallest pulley.
- Roll width approx. 20% bigger than the overall width of the belt unit.
- When installing in the slack section, both belt pulleys must have sufficient wrap angles (driver and driven).

### 2. Selection of the ROSTA tensioner device

Reference value table for the most commonly used V-belt types

V-belt type	Width [mm]	Height [mm]	Diam. of smaller pulley [mm]	Initial operation test-force $F_1^{**}$ [N]	Operational test-force $F_0^{**}$ [N]	Size SE* (without SE-W, SE-B and SE-FE)				
						1 belt	2 belts	3 belts	4 belts	5 belts
XPZ, SPZ	10	8	56–71	20	16	11	18	18	18	18
			75–90	22	18	11	18	18	18	27
			95–125	25	20	15	18	18	18	27
			≥ 125	28	22	15	18	18	27	27
XPA, SPA	13	10	80–100	28	22	15	18	18	27	27
			106–140	38	30	15	18	27	27	27
			150–200	45	36	18	18	27	27	27
			≥ 200	50	40	18	18	27	27	38
XPB, SPB	16	13	112–160	50	40	18	18	27	27	38
			170–224	62	50	18	27	27	38	38
			236–355	77	62	18	27	38	38	38
			≥ 355	81	65	18	27	38	38	38
XPC, SPC	22	18	224–250	87	70	18	27	38	38	38
			265–355	115	92	27	38	38	45	45
			≥ 375	144	115	27	38	38	45	45
Z	10	6	56–100	5–7.5		11	11	11	15	15
A	13	8	80–140	10–15		11	15	18	18	18
B	17	10	125–200	20–30		15	18	18	27	27
C	22	12	200–400	40–60		18	27	27	38	38
D	32	19	355–600	70–105		18	27	38	38	45

\* General basic selection criteria:

- F Resulting tensioning force by a pre-tension angle of  $20^\circ$  (see tensioning force F)
- $F_1$  Initial operation test-force according guidelines of the belt manufacturer
- z Quantity of belts in drive
- 2 Multiplier for the compensation of belt-slippage and/or of centrifugal force generated on belt strands.

\*\* required test-force for belt deflection of 16 mm per 1000 mm of centre distance. The relevant deflection by shorter or longer centre distance has to be interpolated accordingly.

$$F = F_1 \cdot z \cdot 2$$

