

OSCILLATING MOUNTINGS

Elastic suspensions for all types of screening machines, shaker conveyors and gyratory sifters

3

- Components for all types of vibrating machines and conveyors
- Vibration-damping mountings for circular and linear vibrating screens
- Double rocker arms for high-speed vibrating conveyor troughs
- Spring accumulators for machines in near-resonant operation
- Rocker arms and push rod heads for sliding-crank gutters
- Universal joint bearings for gyratory sifter screening machines
- Spring accumulator for resonance-based operation

Product advantages:



long service life

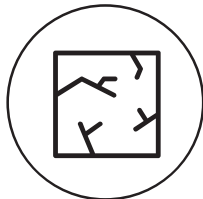

shatterproof



maintenance-free

Selection tables Oscillating Mountings







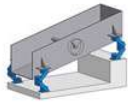

			
One mass system circular motion screen	One mass system linear motion screen	Two mass system with counterframe	One mass system linear motion screen hanging

	Illustration	Type	Description	Page	
Elements for free oscillating systems (with unbalanced excitation)		AB ABI	Oscillating Mounting – universal mounting. High vibration isolation and low residual force transmission. Natural frequencies approx. 2–3 Hz. 9 element sizes from 50 N to 20 000 N.	3.4– 3.5	
		AB-HD ABI-HD	Oscillating Mounting for impact loading and high production peaks, (Heavy Duty). Natural frequencies approx. 2–4 Hz. 11 element sizes from 150 N to 60 000 N.	3.6– 3.7	
		HS HSI		Oscillating Mounting for hanging systems. Natural frequencies approx. 3–5 Hz. 7 element sizes from 150 N to 14 000 N.	3.8
		AB-D		Oscillating Mounting in compact design. Optimal in two mass systems as counter-frame mounting. Natural frequencies approx. 3–4.5 Hz. 7 element sizes from 500 N to 16 000 N.	3.9





	
Gyrotary sifter upright staying	Gyrotary sifter hanging

	Illustration	Type	Description	Page
Elements for gyrotary sifters		AK	Universal joint for the support or suspension of positive drive or freely oscillating gyrotary sifting machines. 10 element sizes up to 40 000 N per AK.	3.19
		AV	Single joint specially designed with a large rubber volume for the suspended gyrotary sifters. Models with right-hand and left-hand threads. 5 element sizes up to 16 000 N per AV.	3.20



		
One mass system «brute-force» system	One mass system «natural frequency» system	Two mass system «fast-runner» system with reaction force compensation

		Illustration	Type	Description	Page
Elements for guided systems (crank driven)			AU AUI	Single Rocker for a variable arm length. Models with right-hand and left-hand threads. 7 element sizes up to 5 000 N.	3.10
			AS-P AS-C	Single rocker with standardized center distance. 6 sizes up to 2 500 N for flange fixation. 6 element sizes up to 2 500 N for central fixation.	3.11– 3.12
			AD-P AD-C	Double rocker with standardized center distance. 5 element sizes up to 2 500 N for flange fixation. 4 element sizes up to 1 600 N for central fixation.	3.13– 3.14
			AR	Single rocker and double rocker with adjustable length, connection of the AR elements using round pipe. Two mass shakers with bi-direction flow are simply to realize. 3 element sizes up to 1 600 N.	3.15
			ST STI	Drive Head for crank drive transmission. Models with right-hand and left-hand threads. 9 element sizes up to 27 000 N.	3.16– 3.17
			DO-A	Spring accumulator with high dynamic spring value for feeder systems running close to resonance frequency. A spring accumulator consists of 2 DO-A elements. 5 element sizes up to dynamic spring value of 320 N/mm.	3.18

Oscillating Mountings

AB / ABI

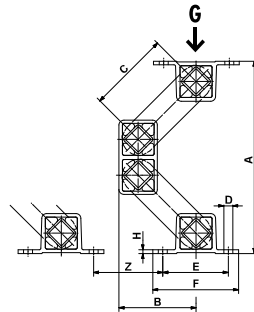

sizes 15 to 27

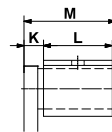

sizes 45 to 50

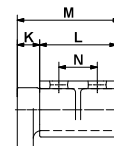

size 38

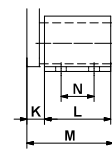

size 50-2

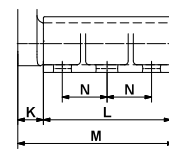

3

Part no.	Type	Load $G_{min.} - G_{max.}$ [N]	A un- loaded	A* max. load	B un- loaded	B* max. load	C	D	E	F	H	K	L	M	N	Weight [kg]
07 051 056	AB 15	50-160	168	114	70	88	80	∅7	50	65	3	10	40	52	-	0.5
07 171 107	ABI 15	70-180	168	114	70	88	80	7 × 10	50	65	3	10	40	52	-	0.8
07 051 057	AB 18	120-350	208	146	88	109	100	∅9	60	80	3.5	14	50	67	-	1.2
07 171 114	ABI 18	120-350	208	146	88	109	100	9 × 15	60	80	3.5	14	50	67	-	1.6
07 051 058	AB 27	250-800	235	170	94	116	100	∅11	80	105	4.5	17	60	80	-	2.3
07 171 109	ABI 27	250-800	235	170	94	116	100	11 × 20	80	105	4.5	17	60	80	-	3.4
07 051 059	AB 38	600-1 600	305	225	120	147	125	∅13	100	125	6	21	80	104	40	5.1
07 171 110	ABI 38	600-1 600	305	225	120	147	125	13 × 20	100	125	6	21	80	104	40	7.6
07 051 054	AB 45	1 200-3 000	353	257	141	172	140	13 × 26	115	145	8	28	100	132	58	11.5
07 171 111	ABI 45	1 200-3 000	353	257	137	168	140	13 × 26	115	145	8	28	100	132	58	13.6
07 051 061	AB 50	2 500-6 000	380	277	150	184	150	17 × 27	130	170	12	35	120	160	60	20.0
07 171 112	ABI 50	2 500-6 000	380	277	150	184	150	17 × 27	130	170	12	35	120	160	60	22.2
07 051 055	AB 50-2	4 200-10 000	380	277	150	184	150	17 × 27	130	170	12	40	200	245	70	31.8
07 171 113	ABI 50-2	4 200-10 000	380	277	150	184	150	17 × 27	130	170	12	40	200	245	70	35.2

Part no.	Type	Natural frequency $G_{min.} - G_{max.}$ [Hz]	Z	Dynamic spring value		Operating parameters by rpm						Material structure				
				vertical [N/mm]	horizontal [N/mm]	720 min ⁻¹		960 min ⁻¹		1 440 min ⁻¹		Aluminium profile	steel welded construction	Nodular cast iron	painted blue	stainless steel casting
						sw	K	sw	K	sw	K					
07 051 056	AB 15	4.0-2.8	65	10	6	14	4.1	12	6.2	8	9.3	×	×	×	×	×
07 171 107	ABI 15	4.0-2.8	65	10	6	14	4.1	12	6.2	8	9.3	×	×	×	×	×
07 051 057	AB 18	3.7-2.6	80	20	14	17	4.9	15	7.7	8	9.3	×	×	×	×	×
07 171 114	ABI 18	3.7-2.6	80	20	14	17	4.9	15	7.7	8	9.3	×	×	×	×	×
07 051 058	AB 27	3.7-2.7	80	40	25	17	4.9	14	7.2	8	9.3	×	×	×	×	×
07 171 109	ABI 27	3.7-2.7	80	40	25	17	4.9	14	7.2	8	9.3	×	×	×	×	×
07 051 059	AB 38	3.0-2.4	100	60	30	20	5.8	17	8.8	8	9.3	×	×	×	×	×
07 171 110	ABI 38	3.0-2.4	100	60	30	20	5.8	17	8.8	8	9.3	×	×	×	×	×
07 051 054	AB 45	2.8-2.3	115	100	50	21	6.1	18	9.3	8	9.3	×	×	×	×	×
07 171 111	ABI 45	2.8-2.3	115	100	50	21	6.1	18	9.3	8	9.3	×	×	×	×	×
07 051 061	AB 50	2.4-2.1	140	190	85	22	6.4	18	9.3	8	9.3	×	×	×	×	×
07 171 112	ABI 50	2.4-2.1	140	190	85	22	6.4	18	9.3	8	9.3	×	×	×	×	×
07 051 055	AB 50-2	2.4-2.1	140	320	140	22	6.4	18	9.3	8	9.3	×	×	×	×	×
07 171 113	ABI 50-2	2.4-2.1	140	320	140	22	6.4	18	9.3	8	9.3	×	×	×	×	×

* compression load $G_{max.}$ and cold flow compensation (after approx. 1 year).

If no other units are specified, the numbers given are in mm.

Dynamic spring value: Values in nominal load range at 960 min⁻¹ and 8 mm of oscillating stroke sw

Operating parameters by rpm: Acceleration > 9.3 g is not recommended

Oscillating Mountings

AB TWIN

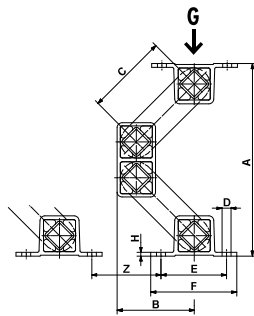

size 50 TWIN

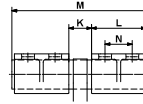

size 50-2 TWIN

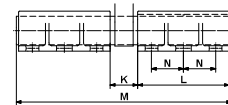

3

Part no.	Type	Load $G_{min.} - G_{max.}$ [N]	A un- loaded	A* max. load	B un- loaded	B* max. load	C	D	E	F	H	K	L	M	N	Weight [kg]
07 051 008	AB 50 TWIN	5 000–12 000	380	277	150	184	150	17 × 27	130	170	12	50	120	300	60	38.2
07 051 009	AB 50-2 TWIN	8 400–20 000	380	277	150	184	150	17 × 27	130	170	12	60	200	470	70	60.2

Part no.	Type	Natural frequency $G_{min.} - G_{max.}$ [Hz]	Z	Operating parameters by rpm								Material structure	
				Dynamic spring value		720 min ⁻¹		960 min ⁻¹		1 440 min ⁻¹			
				vertical [N/mm]	horizontal [N/mm]	sw [mm]	K [-]	sw [mm]	K [-]	sw [mm]	K [-]		
07 051 008	AB 50 TWIN	2.4–2.1	140	380	170	22	6.4	18	9.3	8	9.3	steel welded construction, Nodular cast iron, painted blue	
07 051 009	AB 50-2 TWIN	2.4–2.1	140	640	280	22	6.4	18	9.3	8	9.3		

* compression load $G_{max.}$ and cold flow compensation (after approx. 1 year).

If no other units are specified, the numbers given are in mm.

Dynamic spring value: Values in nominal load range at 960 min⁻¹ and 8 mm of oscillating stroke sw

Operating parameters by rpm: Acceleration > 9.3 g is not recommended

Oscillating Mountings

AB-HD / ABI-HD sizes 15 to 50-2

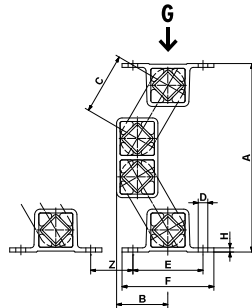

sizes 15 to 27

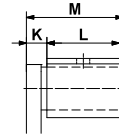

sizes 45 to 50-1.6

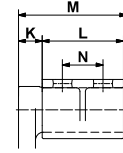

size 38

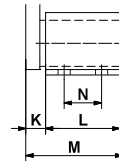

size 50-2

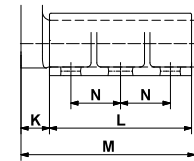

3

Part no.	Type	Load $G_{min.} - G_{max.}$ [N]	A un- loaded	A* max. load	B un- loaded	B* max. load	C	D	E	F	H	K	L	M	N	Weight [kg]
07 171 121	ABI-HD 15	150-400	132	107	36	50	45	7×10	50	65	3	10	40	52	-	0.8
07 171 128	ABI-HD 18	300-700	171	141	47	64	60	9×15	60	80	3.5	14	50	67	-	1.5
07 051 070	AB-HD 27	500-1 250	215	182	59	78	70	∅11	80	105	4.5	17	60	80	-	2.0
07 171 123	ABI-HD 27	500-1 250	215	182	59	78	70	11×20	80	105	4.5	17	60	80	-	3.4
07 051 071	AB-HD 38	1 200-2 500	293	246	79	106	95	∅13	100	125	6	21	80	104	40	4.9
07 171 124	ABI-HD 38	1 200-2 500	293	246	79	106	95	13×20	100	125	6	21	80	104	40	7.6
07 051 072	AB-HD 45	2 000-4 200	346	290	98	130	110	13×26	115	145	8	28	100	132	58	11.0
07 171 125	ABI-HD 45	2 000-4 200	346	290	94	126	110	13×26	115	145	8	28	100	132	58	13.8
07 051 062	AB-HD 50	3 500-8 400	376	313	105	141	120	17×27	130	170	12	40	120	165	60	20.6
07 171 126	ABI-HD 50	3 500-8 400	376	313	105	141	120	17×27	130	170	12	40	120	165	60	21.7
07 051 063	AB-HD 50-1.6	4 800-11 300	376	313	105	141	120	17×27	130	170	12	45	160	210	70	29.1
07 051 060	AB-HD 50-2	6 000-14 000	376	313	105	141	120	17×27	130	170	12	45	200	250	70	32.0
07 171 127	ABI-HD 50-2	6 000-14 000	376	313	105	141	120	17×27	130	170	12	45	200	250	70	35.8

Part no.	Type	Natural frequency $G_{min.} - G_{max.}$ [Hz]	Z	Dynamic spring value		Operating parameters by rpm						Material structure				
				vertical [N/mm]	horizontal [N/mm]	720 min ⁻¹		960 min ⁻¹		1 440 min ⁻¹		Aluminium profile	steel welded construction	Nodular cast iron	painted blue	stainless steel casting
						sw	K	sw	K	sw	K					
07 171 121	ABI-HD 15	5.8-3.6	35	18	10	8	2.3	7	3.6	5	5.8					×
07 171 128	ABI-HD 18	4.9-3.2	50	32	20	10	2.9	9	4.6	7	8.1					×
07 051 070	AB-HD 27	4.8-3.1	60	70	33	12	3.5	10	5.2	8	9.3	×	×		×	
07 171 123	ABI-HD 27	4.8-3.1	60	70	33	12	3.5	10	5.2	8	9.3					×
07 051 071	AB-HD 38	3.6-2.7	90	100	48	15	4.3	13	6.7	8	9.3	×	×		×	
07 171 124	ABI-HD 38	3.6-2.7	90	100	48	15	4.3	13	6.7	8	9.3					×
07 051 072	AB-HD 45	3.3-2.5	100	150	72	17	4.9	14	7.2	8	9.3	×	×	×	×	
07 171 125	ABI-HD 45	3.3-2.5	100	150	72	17	4.9	14	7.2	8	9.3					×
07 051 062	AB-HD 50	3.2-2.4	120	270	130	18	5.2	15	7.7	8	9.3			×	×	
07 171 126	ABI-HD 50	3.2-2.4	120	270	130	18	5.2	15	7.7	8	9.3					×
07 051 063	AB-HD 50-1.6	3.2-2.4	120	360	172	18	5.2	15	7.7	8	9.3		×	×	×	
07 051 060	AB-HD 50-2	3.2-2.4	120	450	215	18	5.2	15	7.7	8	9.3			×	×	
07 171 127	ABI-HD 50-2	3.2-2.4	120	450	215	18	5.2	15	7.7	8	9.3					×

* compression load $G_{max.}$ and cold flow compensation (after approx. 1 year).

If no other units are specified, the numbers given are in mm.

Dynamic spring value: Values in nominal load range at 960 min⁻¹ and 8 mm of oscillating stroke sw

Operating parameters by rpm: Acceleration > 9.3 g is not recommended

Oscillating Mountings

AB-HD sizes 70-3 to 100-4

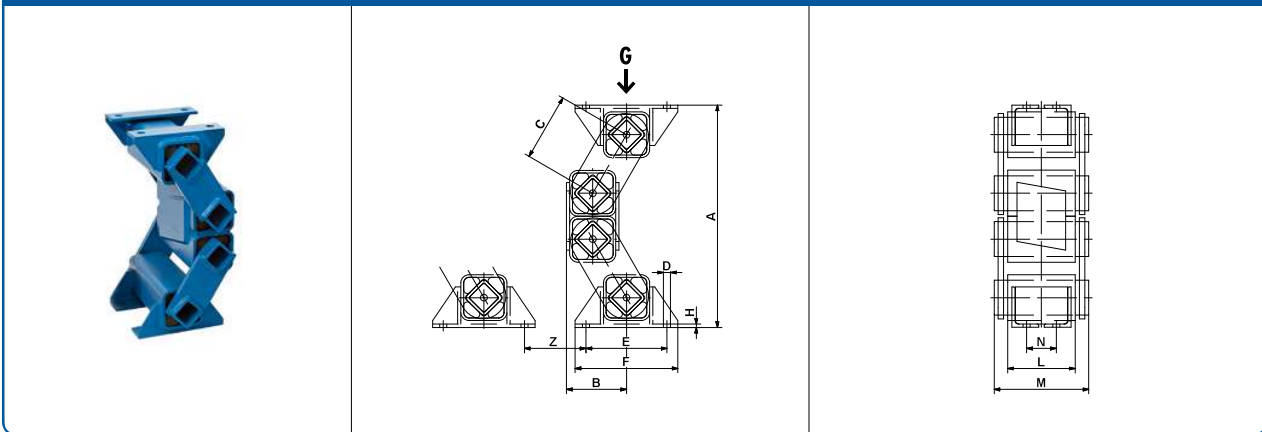

3

Part no.	Type	Load $G_{min.} - G_{max.}$ [N]	A un- loaded	A* max. load	B un- loaded	B* max. load	C	$\varnothing D$	E	F	H	L	M	N	Weight [kg]
07 051 076	AB-HD 70-3	9 000–20 000	592	494	160	215	180	22	200	260	9	300	380	200	82
07 051 080	AB-HD 100-2.5	15 000–37 000	823	676	222	302	250	26	300	380	12	250	350	110	170
07 051 081	AB-HD 100-4	25 000–60 000	823	676	222	302	250	26	300	380	12	400	500	260	230

Part no.	Type	Natural frequency $G_{min.} - G_{max.}$ [Hz]	Z	Operating parameters by rpm								Material structure
				Dynamic spring value		720 min ⁻¹		960 min ⁻¹		1 440 min ⁻¹		
				vertical [N/mm]	horizontal [N/mm]	sw [mm]	K [-]	sw [mm]	K [-]	sw [mm]	K [-]	
07 051 076	AB-HD 70-3	2.4–2.1	200	670	320	25	7.3	18	9.3	8	9.3	steel welded construction, painted blue
07 051 080	AB-HD 100-2.5	2.4–1.8	250	1 150	530	30	8.6	18	9.3	8	9.3	
07 051 081	AB-HD 100-4	2.4–1.8	250	1 840	850	30	8.6	18	9.3	8	9.3	

* compression load $G_{max.}$ and cold flow compensation (after approx. 1 year).

If no other units are specified, the numbers given are in mm.

Customized Oscillating Mountings Type AB-HD with low natural frequency and high load capacity.

The sizes 100-2.5 to AB-HD 100-4 can be combined with one another (identical heights and operation behaviour).

Dynamic spring value: Values in nominal load range at 960 min⁻¹ and 8 mm of oscillating stroke sw

Operating parameters by rpm: Acceleration > 9.3g is not recommended

Oscillating Mountings

HS / HSI

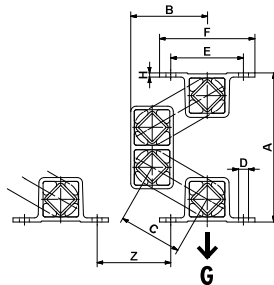

sizes 15 to 38

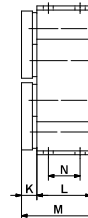

sizes 45 to 50

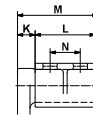

size 50-2

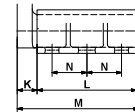

3

Part no.	Type	Load $G_{min.} - G_{max.}$ [N]	A un- loaded	A* max. load	B un- loaded	B* max. load	C	D	E	F	H	K	L	M	N	Weight [kg]
07 321 101	HSI 15	150-400	99	125	53	42	45	∅7	50	65	3	10	40	52	25	0.8
07 321 102	HSI 18	300-700	127	159	69	56	60	∅9	60	80	3.5	14	50	67	30	1.5
07 311 001	HS 27	500-1 250	164	202	84	68	70	∅11	80	105	4.5	17	60	80	35	2.0
07 321 103	HSI 27	500-1 250	164	202	84	68	70	∅11	80	105	4.5	17	60	80	35	3.4
07 311 002	HS 38	1 200-2 500	223	275	114	92	95	∅13	100	125	6	21	80	104	40	4.82
07 321 104	HSI 38	1 200-2 500	223	275	114	92	95	13×20	100	125	6	21	80	104	40	7.3
07 311 003	HS 45	2 000-4 200	265	325	138	113	110	13×26	115	145	8	28	100	132	58	10.99
07 321 105	HSI 45	2 000-4 200	265	325	134	109	110	13×26	115	145	8	28	100	132	58	13.6
07 311 004	HS 50	3 500-8 400	288	357	148	118	120	17×27	130	170	12	40	120	165	60	20.32
07 321 106	HSI 50	3 500-8 400	288	357	148	118	120	17×27	130	170	12	40	120	165	60	22.3
07 311 005	HS 50-2	6 000-14 000	288	357	148	118	120	17×27	130	170	12	45	200	250	70	31.8
07 321 107	HSI 50-2	6 000-14 000	288	357	148	118	120	17×27	130	170	12	45	200	250	70	35.8

Part no.	Type	Natural frequency $G_{min.} - G_{max.}$ [Hz]	Z	Dynamic spring value		Operating parameters by rpm						Material structure				
				cd		720 min ⁻¹		960 min ⁻¹		1 440 min ⁻¹		Aluminium profile	steel welded construction	Nodular cast iron	painted blue	stainless steel casting
				vertical [N/mm]	horizontal [N/mm]	sw [mm]	max. [-]	sw [mm]	max. [-]	sw [mm]	max. [-]					
07 321 101	HSI 15	5.2-4.7	35	17	10	8	2.3	7	3.6	5	5.8					×
07 321 102	HSI 18	4.5-4.0	50	30	19	10	2.9	9	4.6	7	8.1					×
07 311 001	HS 27	4.2-3.8	60	65	32	12	3.5	10	5.2	8	9.3	×	×		×	
07 321 103	HSI 27	4.2-3.8	60	65	32	12	3.5	10	5.2	8	9.3					×
07 311 002	HS 38	3.6-3.3	90	95	46	15	4.3	13	6.7	8	9.3	×	×		×	
07 321 104	HSI 38	3.6-3.3	90	95	46	15	4.3	13	6.7	8	9.3					×
07 311 003	HS 45	3.3-3.0	100	142	70	17	4.9	14	7.2	8	9.3	×	×	×	×	
07 321 105	HSI 45	3.3-3.0	100	142	70	17	4.9	14	7.2	8	9.3					×
07 311 004	HS 50	3.2-2.9	120	245	120	18	5.2	15	7.7	8	9.3				×	×
07 321 106	HSI 50	3.2-2.9	120	245	120	18	5.2	15	7.7	8	9.3					×
07 311 005	HS 50-2	3.2-2.9	120	410	200	18	5.2	15	7.7	8	9.3				×	×
07 321 107	HSI 50-2	3.2-2.9	120	410	200	18	5.2	15	7.7	8	9.3					×

* tensile load $G_{max.}$ and cold flow compensation (after approx. 1 year).

If no other units are specified, the numbers given are in mm.

Dynamic spring value: Values in nominal load range at 960 min⁻¹ and 8 mm of oscillating stroke sw

Operating parameters by rpm: Acceleration > 9.3 g is not recommended

Oscillating Mountings

AB-D

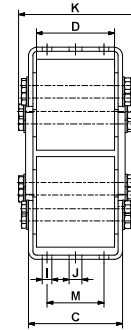
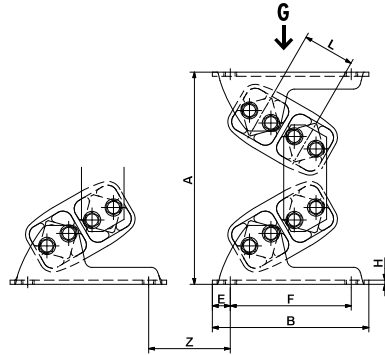

Part no.	Type	Load $G_{min.} - G_{max.}$ [N]	A un- loaded	A* max. load	B	C	D	E	F	H	I	J	K	L	M	Weight [kg]
07 281 000	AB-D 18	500–1 200	137	112	115	61	50	12.5	90	3	9	9	74	31	30	1.1
07 281 001	AB-D 27	1 000–2 500	184	148	150	93	80	15	120	4	9	11	116	44	50	3.1
07 281 002	AB-D 38	2 000–4 000	244	199	185	118	100	17.5	150	5	11	13.5	147	60	70	6.8
07 281 003	AB-D 45	3 000–6 000	298	240	220	132	110	25	170	6	13.5	18	168	73	80	11.2
07 281 004	AB-D 50	4 000–9 000	329	272	235	142	120	25	185	6	13.5	18	166	78	90	18.4
07 281 005	AB-D 50-1.6	6 000–12 000	329	272	235	186	160	25	185	8	13.5	18	214	78	90	24.0
07 281 006	AB-D 50-2	8 000–16 000	329	272	235	226	200	25	185	8	13.5	18	260	78	90	30.4

Part no.	Type	Natural frequency $G_{min.} - G_{max.}$ [Hz]	Z	Dynamic spring value			Operating parameters by rpm						Material structure (zinc-plated couplings)			
				vertical [N/mm]	at sw [N/mm]	horizontal [N/mm]	720 min ⁻¹		960 min ⁻¹		1 440 min ⁻¹		Aluminium profile	Steel plate	Nodular cast iron	painted blue
							cd	cd	cd	sw	K	sw				
07 281 000	AB-D 18	6.1–4.4	30	100	4	20	5	1.4	5	2.6	4	4.6	×	×		×
07 281 001	AB-D 27	5.4–3.9	35	160	4	35	7	2.0	6	3.1	5	5.8	×	×		partially
07 281 002	AB-D 38	4.3–3.4	40	185	6	40	9	2.6	8	4.1	6	7.0	×	×		partially
07 281 003	AB-D 45	3.7–3.1	55	230	8	70	11	3.2	9	4.6	7	8.1	×	×		partially
07 281 004	AB-D 50	3.7–2.9	55	310	8	120	12	3.5	10	5.2	8	9.3	×	×	×	×
07 281 005	AB-D 50-1.6	3.6–2.9	55	430	8	160	12	3.5	10	5.2	8	9.3	×	×	×	×
07 281 006	AB-D 50-2	3.5–2.8	55	540	8	198	12	3.5	10	5.2	8	9.3	×	×	×	×

* compression load $G_{max.}$ and cold flow compensation (after approx. 1 year).

If no other units are specified, the numbers given are in mm.

Dynamic spring value: Values in nominal load range at 960 min⁻¹

Operating parameters by rpm: Acceleration > 9.3g is not recommended

Oscillating Mountings

AU / AUI

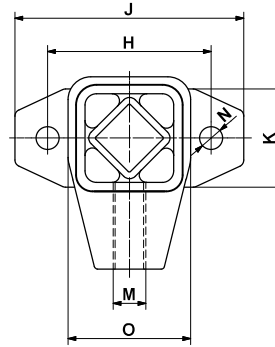
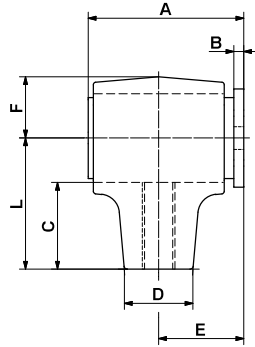

Fixation flange AU 60

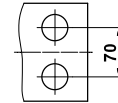

3

Part no.	Type	G [N] K<2	Mdd [Nm/°]	A	B	C	□D	E	F	H	J	K	L	M	øN	O	Weight [kg]
07 011 001	AU 15	100	0.44	50	4	29	20	28	17	50	70	25	40	M10	7	33	0.2
07 021 001	AU 15L	100	0.44	50	4	29	20	28	17	50	70	25	40	M10-LH	7	33	0.2
07 131 111	AUI 15	100	0.44	50	4	29	20	28	17	50	70	25	40	M10	7	33	0.4
07 141 111	AUI 15L	100	0.44	50	4	29	20	28	17	50	70	25	40	M10-LH	7	33	0.4
07 011 002	AU 18	200	1.32	62	5	31.5	22	34	20	60	85	35	45	M12	9.5	39	0.3
07 021 002	AU 18L	200	1.32	62	5	31.5	22	34	20	60	85	35	45	M12-LH	9.5	39	0.3
07 131 112	AUI 18	200	1.32	62	5	31.5	22	34	20	60	85	35	45	M12	9	39	0.5
07 141 112	AUI 18L	200	1.32	62	5	31.5	22	34	20	60	85	35	45	M12-LH	9	39	0.5
07 011 003	AU 27	400	2.6	73	5	40.5	28	40	27	80	110	45	60	M16	11.5	54	0.6
07 021 003	AU 27L	400	2.6	73	5	40.5	28	40	27	80	110	45	60	M16-LH	11.5	54	0.6
07 131 113	AUI 27	400	2.6	73	5	40.5	28	40	27	80	110	45	60	M16	11	54	1.2
07 141 113	AUI 27L	400	2.6	73	5	40.5	28	40	27	80	110	45	60	M16-LH	11	54	1.2
07 011 004	AU 38	800	6.7	95	6	53	42	52	37	100	140	60	80	M20	14	74	1.5
07 021 004	AU 38L	800	6.7	95	6	53	42	52	37	100	140	60	80	M20-LH	14	74	1.5
07 011 005	AU 45	1600	11.6	120	8	67	48	66	44	130	180	70	100	M24	18	89	2.7
07 021 005	AU 45L	1600	11.6	120	8	67	48	66	44	130	180	70	100	M24-LH	18	89	2.7
07 011 006	AU 50	2500	20.4	145	10	69.5	60	80	47	140	190	80	105	M36	18	93	6.3
07 021 006	AU 50L	2500	20.4	145	10	69.5	60	80	47	140	190	80	105	M36-LH	18	93	6.3
07 011 007	AU 60	5000	38.2	233	15	85	80	128	59	180	230	120	130	M42	18	116	15.6
07 021 007	AU 60L	5000	38.2	233	15	85	80	128	59	180	230	120	130	M42-LH	18	116	15.7

If no other units are specified, the numbers given are in mm.

G = max. load in N per element or rocker, by higher accelerations K, consult page 7.26.

Mdd = dynamic element torque in Nm/° by oscillation angles $\alpha \pm 5^\circ$ in speed range of $n_s = 300 - 600 \text{ min}^{-1}$.

AU: Inner square steel welded construction. Housing sizes 15–45 Aluminium cast, sizes 50 and 60 nodular cast iron. Painted blue.

AUI: Stainless steel casting.

Oscillating Mountings

AS-P / AS-PV

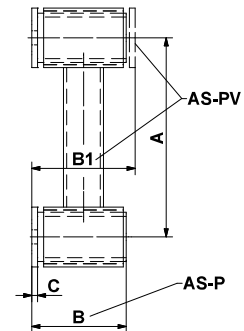
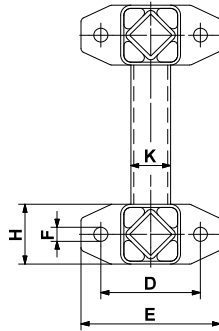

3

Part no.	Type	G [N] K<2	cd [N/mm]	A	B	B1	C	D	E	øF	H	øK	Weight [kg]	Material structure
07 081 001	AS-P 15	100	5	100	50	–	4	50	70	7	25	18	0.5	Steel welded constructions, painted blue. Inner square analogous to type AU.
07 091 001	AS-PV 15	100	5	100	–	56	4	50	70	7	25	18	0.4	
07 081 002	AS-P 18	200	11	120	62	–	5	60	85	9.5	35	24	0.7	
07 091 002	AS-PV 18	200	11	120	–	68	5	60	85	9.5	35	24	0.7	
07 081 003	AS-P 27	400	12	160	73	–	5	80	110	11.5	45	34	1.5	
07 091 003	AS-PV 27	400	12	160	–	80	5	80	110	11.5	45	34	1.5	
07 081 004	AS-P 38	800	19	200	95	–	6	100	140	14	60	40	2.8	
07 091 004	AS-PV 38	800	19	200	–	104	6	100	140	14	60	40	3.6	
07 081 005	AS-P 45	1600	33	200	120	–	8	130	180	18	70	45	4.7	
07 091 005	AS-PV 45	1600	33	200	–	132	8	130	180	18	70	45	4.7	
07 081 006	AS-P 50	2500	37	250	145	–	10	140	190	18	80	60	8.3	
07 091 006	AS-PV 50	2500	37	250	–	160	10	140	190	18	80	60	8.3	

If no other units are specified, the numbers given are in mm.

G = max. load in N per element or rocker, by higher accelerations K, consult page 7.26.

cd = dynamic spring value by oscillation angles $\alpha \pm 5^\circ$ in speed range of $n_s = 300 - 600 \text{ min}^{-1}$

AS-P for flange fixation.

AS-PV for flange fixation with inverted flange.

Oscillating Mountings

AS-C

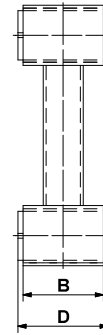
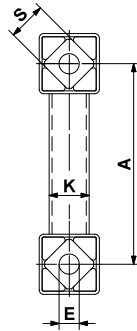

3

Part no.	Type	G [N] K<2	cd [N/mm]	A	B	D	$\varnothing E$	$\varnothing K$	$\square S$	Weight [kg]	Material structure
07 071 001	AS-C 15	100	5	100	40	45 ⁰ _{-0.3}	10 ^{+0.4} _{-0.2}	18	15	0.3	Steel welded construction, aluminium profile, painted blue.
07 071 002	AS-C 18	200	11	120	50	55 ⁰ _{-0.3}	13 ⁰ _{-0.2}	24	18	0.5	
07 071 003	AS-C 27	400	12	160	60	65 ⁰ _{-0.3}	16 ^{+0.5} _{-0.3}	34	27	1.0	
07 071 004	AS-C 38	800	19	200	80	90 ⁰ _{-0.3}	20 ^{+0.5} _{-0.2}	40	38	1.9	
07 071 005	AS-C 45	1600	33	200	100	110 ⁰ _{-0.3}	24 ^{+0.5} _{-0.2}	45	45	2.9	
07 071 006	AS-C 50	2500	37	250	120	130 ⁰ _{-0.3}	30 ^{+0.5} _{-0.2}	60	50	6.1	

If no other units are specified, the numbers given are in mm.

G = max. load in N per element or rocker, by higher accelerations K, consult page 7.26.

cd = dynamic spring value by oscillation angles $\alpha \pm 5^\circ$ in speed range of $n_s = 300 - 600 \text{ min}^{-1}$

AS-C for center connection.

Oscillating Mountings

AD-P / AD-PV

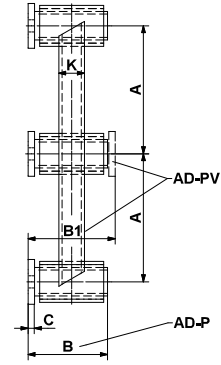
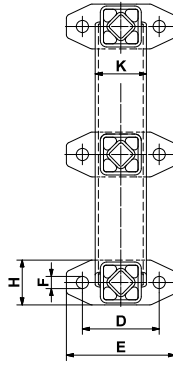

3

Part no.	Type	G [N]		cd [N/mm]	A	B	B1	C	D	E	øF	H	K	Weight [kg]	Material structure
		K=2	K=3												
07 111 001	AD-P 18	150	120	23	100	62	—	5	60	85	9.5	35	40 × 20	1.2	Steel welded constructions, painted blue. Inner square analogous to type AU.
07 121 001	AD-PV 18	150	120	23	100	—	68	5	60	85	9.5	35	40 × 20	1.2	
07 111 002	AD-P 27	300	240	31	120	73	—	5	80	110	11.5	45	55 × 34	2.3	
07 121 002	AD-PV 27	300	240	31	120	—	80	5	80	110	11.5	45	55 × 34	2.3	
07 111 003	AD-P 38	600	500	45	160	95	—	6	100	140	14	60	70 × 50	5.0	
07 121 003	AD-PV 38	600	500	45	160	—	104	6	100	140	14	60	70 × 50	5.0	
07 111 004	AD-P 45	1200	1000	50	200	120	—	8	130	180	18	70	80 × 40	8.5	
07 121 004	AD-PV 45	1200	1000	50	200	—	132	8	130	180	18	70	80 × 40	8.2	
07 111 005	AD-P 50	1800	1500	56	250	145	—	10	140	190	18	80	90 × 50	12.7	
07 121 005	AD-PV 50	1800	1500	56	250	—	160	10	140	190	18	80	90 × 50	12.6	

If no other units are specified, the numbers given are in mm.

G = max. load in N per element or rocker, by higher accelerations K, consult page 7.26.

cd = dynamic spring value by oscillation angles $\alpha \pm 5^\circ$ in speed range of $n_s = 300 - 600 \text{ min}^{-1}$

AD-P for flange fixation.

AD-PV for flange fixation with inverted flange.

Oscillating Mountings

AD-C

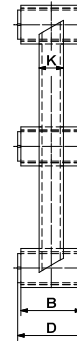
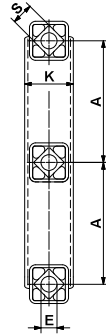

3

Part no.	Type	G [N]		cd [N/mm]	A	B	D	$\varnothing E$	K	□S	Weight [kg]	Material structure
		K=2	K=3									
07 101 001	AD-C 18	150	120	23	100	50	55 ⁰ _{-0.3}	13 ⁰ _{-0.2}	40 × 20	18	0.8	Steel welded construction, aluminium profile, painted blue.
07 101 002	AD-C 27	300	240	31	120	60	65 ⁰ _{-0.3}	16 ^{+0.5} _{-0.3}	55 × 34	27	1.6	
07 101 003	AD-C 38	600	500	45	160	80	90 ⁰ _{-0.3}	20 ^{+0.5} _{-0.2}	70 × 50	38	3.7	
07 101 004	AD-C 45	1200	1000	50	200	100	110 ⁰ _{-0.3}	24 ^{+0.5} _{-0.2}	80 × 40	45	6.1	

If no other units are specified, the numbers given are in mm.

G = max. load in N per element or rocker, by higher accelerations K, consult page 7.26.

cd = dynamic spring value by oscillation angles $\alpha \pm 5^\circ$ in speed range of $n_s = 300 - 600 \text{ min}^{-1}$

AD-C for center connection.

Oscillating Mountings

AR

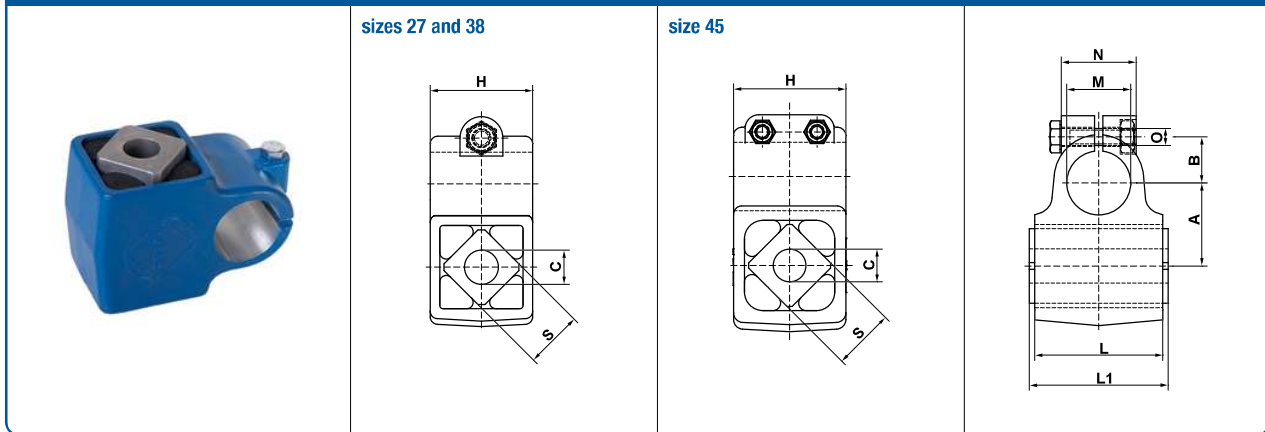

Part no.	Type	G [N] K<2	Mdd [Nm/°]	A	B	øC	H	L	L1	øM	N	O	□S	Weight [kg]	Material structure
07 291 003	AR 27	400	2.6	39 ±0.2	21.5	16 ^{+0.5} _{-0.3}	48	60	65 ⁰ _{-0.3}	30	35	M8	27	0.4	Aluminium profile, Aluminium cast, painted blue
07 291 004	AR 38	800	6.7	52 ±0.2	26.5	20 ^{+0.5} _{-0.2}	64	80	90 ⁰ _{-0.3}	40	50	M8	38	0.9	
07 291 005	AR 45	1600	11.6	65 ±0.2	32.5	24 ^{+0.5} _{-0.2}	82	100	110 ⁰ _{-0.3}	50	60	M10	45	2.0	

If no other units are specified, the numbers given are in mm.

G = max. load in N per element or rocker, by higher accelerations K, consult page 7.26.

Mdd = dynamic element torque in Nm/° by oscillation angles $\alpha \pm 5^\circ$ in speed range of $n_s = 300 - 600 \text{ min}^{-1}$.

For further information see chapter 7 Technology.

Oscillating Mountings

ST

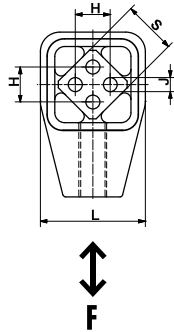

sizes 18 to 50

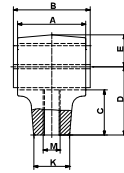

size 60

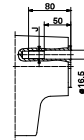

size 50-2

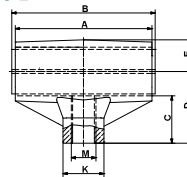

sizes 60-3 and 80

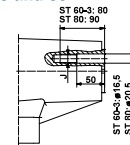

3

Part no.	Type	F max. [N]	n _s [min ⁻¹] max. α _{ST} ± 5°	A	B	C	D	E	H	J	□K	L	M	□S	Weight [kg]
07 031 001	ST 18	400	600	50	55 ⁰ _{-0.3}	31.5	45	20	12 ±0.3	6 ^{+0.5} ₋₀	22	39	M12	18	0.2
07 041 001	ST 18L	400	600	50	55 ⁰ _{-0.3}	31.5	45	20	12 ±0.3	6 ^{+0.5} ₋₀	22	39	M12-LH	18	0.2
07 031 002	ST 27	1000	560	60	65 ⁰ _{-0.3}	40.5	60	27	20 ±0.4	8 ^{+0.5} ₋₀	28	54	M16	27	0.4
07 041 002	ST 27L	1000	560	60	65 ⁰ _{-0.3}	40.5	60	27	20 ±0.4	8 ^{+0.5} ₋₀	28	54	M16-LH	27	0.4
07 031 003	ST 38	2000	530	80	90 ⁰ _{-0.3}	53	80	37	25 ±0.4	10 ^{+0.5} ₋₀	42	74	M20	38	1.1
07 041 003	ST 38L	2000	530	80	90 ⁰ _{-0.3}	53	80	37	25 ±0.4	10 ^{+0.5} ₋₀	42	74	M20-LH	38	1.1
07 031 004	ST 45	3500	500	100	110 ⁰ _{-0.3}	67	100	44	35 ±0.5	12 ^{+0.5} ₋₀	48	89	M24	45	1.8
07 041 004	ST 45L	3500	500	100	110 ⁰ _{-0.3}	67	100	44	35 ±0.5	12 ^{+0.5} ₋₀	48	89	M24-LH	45	1.8
07 031 005	ST 50	6000	470	120	130 ⁰ _{-0.3}	69.5	105	47	40 ±0.5	M12 × 40	60	93	M36	50	5.0
07 041 005	ST 50L	6000	470	120	130 ⁰ _{-0.3}	69.5	105	47	40 ±0.5	M12 × 40	60	93	M36-LH	50	5.0
07 031 015	ST 50-2	10000	470	200	210 ⁰ _{-0.3}	69.5	105	47	40 ±0.5	M12 × 40	60	93	M36	50	7.0
07 041 015	ST 50-2L	10000	470	200	210 ⁰ _{-0.3}	69.5	105	47	40 ±0.5	M12 × 40	60	93	M36-LH	50	7.1
07 031 026	ST 60	13000	440	200	210 ^{+0.2} _{-0.2}	85	130	59	45	M16	80	117	M42	60	15.6
07 041 026	ST 60L	13000	440	200	210 ^{+0.2} _{-0.2}	85	130	59	45	M16	80	117	M42-LH	60	14.9
07 031 016	ST 60-3	20000	440	300	310 ^{+0.2} _{-0.2}	85	130	59	45	M16	75	117	M42	60	20.0
07 041 016	ST 60-3L	20000	440	300	310 ^{+0.2} _{-0.2}	85	130	59	45	M16	75	117	M42-LH	60	20.0
07 031 027	ST 80	27000	380	300	310 ^{+0.2} _{-0.2}	100	160	77	60	M20	90	150	M52	80	34.0
07 041 027	ST 80L	27000	380	300	310 ^{+0.2} _{-0.2}	100	160	77	60	M20	90	150	M52-LH	80	34.0

If no other units are specified, the numbers given are in mm.

F_{max.}: Calculation of the acceleration force page 7.22.

n_s = max. revolutions by oscillation angle + 5°; if osc. angle is below, higher rpm's are applicable, see «permissible frequencies» in chapter 7 Technology.

Sizes 18 to 45: Inner square Aluminium profile. Housing Aluminium cast. Housing painted blue.

Sizes 50 to 50-2: Inner square Aluminium profile. Housing nodular cast iron. Housing painted blue.

Sizes 60 to 80: Inner square steel. Housing nodular cast iron. Painted blue.

Oscillating Mountings

STI

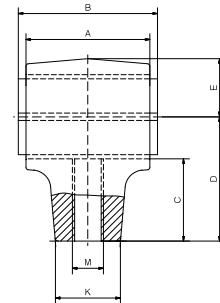
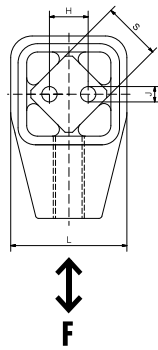

Part no.	Type	F max. [N]	n_s [min^{-1}] max. $\alpha_{ST} \pm 5^\circ$	A	B	C	D	E	H	J	□K	L	M	□S	Weight [kg]	Material structure
07 151 111	STI 18	400	600	50	55 ⁰ _{-0,3}	31,5	45	20	12 ^{±0,3}	6	22	39	M12	18	0,5	Stainless steel casting and inner square solid material stainless
07 161 111	STI 18L	400	600	50	55 ⁰ _{-0,3}	31,5	45	20	12 ^{±0,3}	6	22	39	M12-L	18	0,5	
07 151 112	STI 27	1 000	560	60	65 ⁰ _{-0,3}	40,5	60	27	20 ^{±0,4}	8	28	54	M16	27	1,1	
07 161 112	STI 27L	1 000	560	60	65 ⁰ _{-0,3}	40,5	60	27	20 ^{±0,4}	8	28	54	M16-L	27	1,1	

If no other units are specified, the numbers given are in mm.

$F_{max.}$: Calculation of the acceleration force page 7.22.

n_s = max. revolutions by oscillation angle $+ 5^\circ$; if osc. angle is below, higher rpm's are applicable, see «permissible frequencies» in chapter 7 Technology.

Oscillating Mountings

DO-A as a spring accumulator



sizes 15 to 45

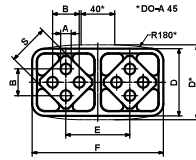

sizes 15 to 45

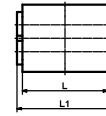

size 50

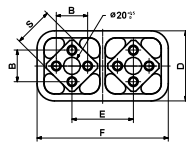

size 50

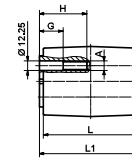

3

Part no.	Type	c_s [N/mm]	A	B	D	E	F	ϕI	$\square S$	G	H	L	L1	Weight [kg]	Material structure		
															Aluminium profile	Nodular cast	Painted blue
01 041 013	DO-A 45 x 80	100	12 ^{+0,5} ₋₀	35 ±0.5	85	73	150	—	45	—	—	80	90 ⁰ _{-0,3}	1.9	×	×	×
01 041 014	DO-A 45 x 100	125	12 ^{+0,5} ₋₀	35 ±0.5	85	73	150	—	45	—	—	100	110 ⁰ _{-0,3}	2.3	×	×	×
01 041 016	DO-A 50 x 120	190	M12	40 ±0.5	89	78	168	12.25	50	30	60	120	130 ⁰ _{-0,3}	5.5	×	×	×
01 041 019	DO-A 50 x 160	255	M12	40 ±0.5	89	78	168	12.25	50	30	60	160	170 ⁰ _{-0,3}	7.4	×	×	×
01 041 017	DO-A 50 x 200	320	M12	40 ±0.5	89	78	168	12.25	50	40	70	200	210 ⁰ _{-0,3}	8.5	×	×	×

If no other units are specified, the numbers given are in mm.

c_s = dynamic spring value of the complete accumulator by oscillating angle of $\pm 5^\circ$ and revolutions n_s between 300–600 min⁻¹.

1 spring accumulator is always consisting of 2 pcs. DO-A elements, for further information see chapter 7 Technology.

Oscillating Mountings

AK

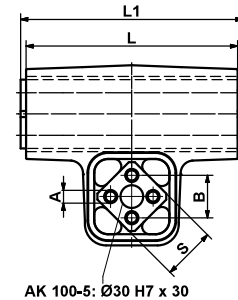
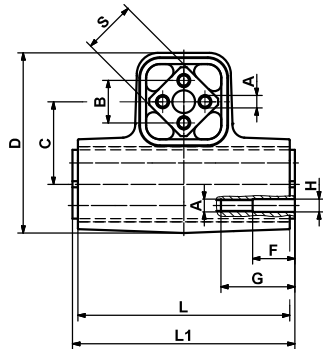

AK 100-5: Ø30 H7 x 30

3

Part no.	Type	Max. load G [N] for the gyratory type:			A	B	C	D	F
		hanging	staying, crank driven	staying, free oscillating					
07 061 001	AK 15	160	128	80	5 ^{+0.5} ₋₀	10 ±0.2	27	54	—
07 061 002	AK 18	300	240	150	6 ^{+0.5} ₋₀	12 ±0.3	32	64	—
07 061 003	AK 27	800	640	400	8 ^{+0.5} ₋₀	20 ±0.4	45	97	—
07 061 004	AK 38	1600	1280	800	10 ^{+0.5} ₋₀	25 ±0.4	60	130	—
07 061 005	AK 45	3000	2400	1500	12 ^{+0.5} ₋₀	35 ±0.5	72	156	—
07 061 011	AK 50	5600	4480	2800	M12	40 ±0.5	78	172	40
07 061 012	AK 60	10000	8000	5000	M16	45	100	218	50
07 061 013	AK 80	20000	16000	10000	M20	60	136	283	50
07 061 009	AK 100-4	30000	24000	15000	M24	75	170	354	50
07 061 010	AK 100-5	40000	32000	20000	M24	75	170	340	50

Part no.	Type	G	øH	L	L1	□S	Weight [kg]	Material structure			Mounting inner square
								Inner square	Housing	Paint	
07 061 001	AK 15	—	—	60	65 ±0.2	15	0.3	Aluminium profile	steel welded construction	painted blue	End-to-end screw or threaded bar quality 8.8
07 061 002	AK 18	—	—	80	85 ±0.2	18	0.5				
07 061 003	AK 27	—	—	100	105 ±0.2	27	1.8				
07 061 004	AK 38	—	—	120	130 ±0.2	38	3.8				
07 061 005	AK 45	—	—	150	160 ±0.2	45	6.3				
07 061 011	AK 50	70	12.25	200	210 ±0.2	50	10.8	Steel	steel welded construction	Shoulder studs quality 8.8 for optimizing frictional connection	
07 061 012	AK 60	80	16.5	300	310 ±0.2	60	37.4				
07 061 013	AK 80	90	20.5	400	410 ±0.2	80	85.8				
07 061 009	AK 100-4	100	25	400	410 ±0.2	100	121.6				
07 061 010	AK 100-5	100	25	500	510 ±0.2	100	136.6				

If no other units are specified, the numbers given are in mm.

G = max. load in N per support column

Usual drive parameters from experience: Driving speed n_s up to approx. 380 min⁻¹, Oscillation angle α up to approx. ±3.5°.

Limitation of application parameters see «permissible frequencies» in chapter 7 Technology.

For further information see chapter 7 Technology.

Oscillating Mountings

AV

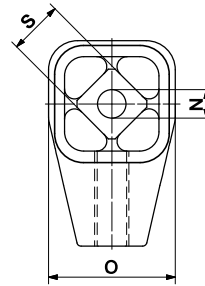
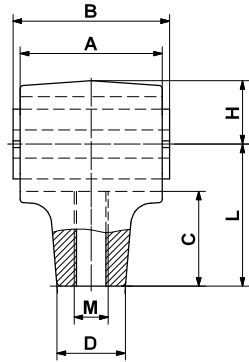

Inner square sizes 50 and 50L

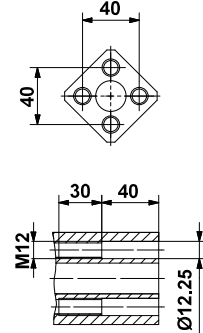

3

Part no.	Type	G [N] per suspension	A	B	C	□D	H	L	M
07 261 001	AV 18	600–1 600	60	65 ±0.2	40.5	28	27	60	M16
07 271 001	AV 18L	600–1 600	60	65 ±0.2	40.5	28	27	60	M16-LH
07 261 002	AV 27	1 300–3 000	80	90 ±0.2	53	42	37	80	M20
07 271 002	AV 27L	1 300–3 000	80	90 ±0.2	53	42	37	80	M20-LH
07 261 003	AV 38	2 600–5 000	100	110 ±0.2	67	48	44	100	M24
07 271 003	AV 38L	2 600–5 000	100	110 ±0.2	67	48	44	100	M24-LH
07 261 014	AV 40	4 500–7 500	120	130 ±0.2	69.5	60	47	105	M36
07 271 014	AV 40L	4 500–7 500	120	130 ±0.2	69.5	60	47	105	M36-LH
07 261 005	AV 50	6 000–16 000	200	210 ±0.2	85	80	59	130	M42
07 271 005	AV 50L	6 000–16 000	200	210 ±0.2	85	80	59	130	M42-LH

Part no.	Type	øN	O	□S	Weight [kg]	Material structure			Mounting inner square
						Inner square	Housing	Paint	
07 261 001	AV 18	13 ⁰ _{-0.2}	54	18	0.4	Aluminium profile	Aluminium cast	painted blue	End-to-end screw or threaded bar quality 8.8.
07 271 001	AV 18L	13 ⁰ _{-0.2}	54	18	0.4				
07 261 002	AV 27	16 ^{+0.5} _{-0.3}	74	27	1.0				
07 271 002	AV 27L	16 ^{+0.5} _{-0.3}	74	27	1.0				
07 261 003	AV 38	20 ^{+0.5} _{-0.2}	89	38	1.7				
07 271 003	AV 38L	20 ^{+0.5} _{-0.2}	89	38	1.7				
07 261 014	AV 40	20 ^{+0.5} _{-0.2}	93	40	4.8				
07 271 014	AV 40L	20 ^{+0.5} _{-0.2}	93	40	4.8				
07 261 005	AV 50	–	116	50	12.3	Nodular cast		M12 shoulder studs quality 8.8.	
07 271 005	AV 50L	–	116	50	12.3				

If no other units are specified, the numbers given are in mm.

G = max. load in N per suspension

Elements for higher load on request

Limitation of application parameters see «permissible frequencies» in chapter 7 Technology.

The threaded connection rod has to be provided by the customer.

Oscillating mountings – free oscillating systems

Vibration isolation

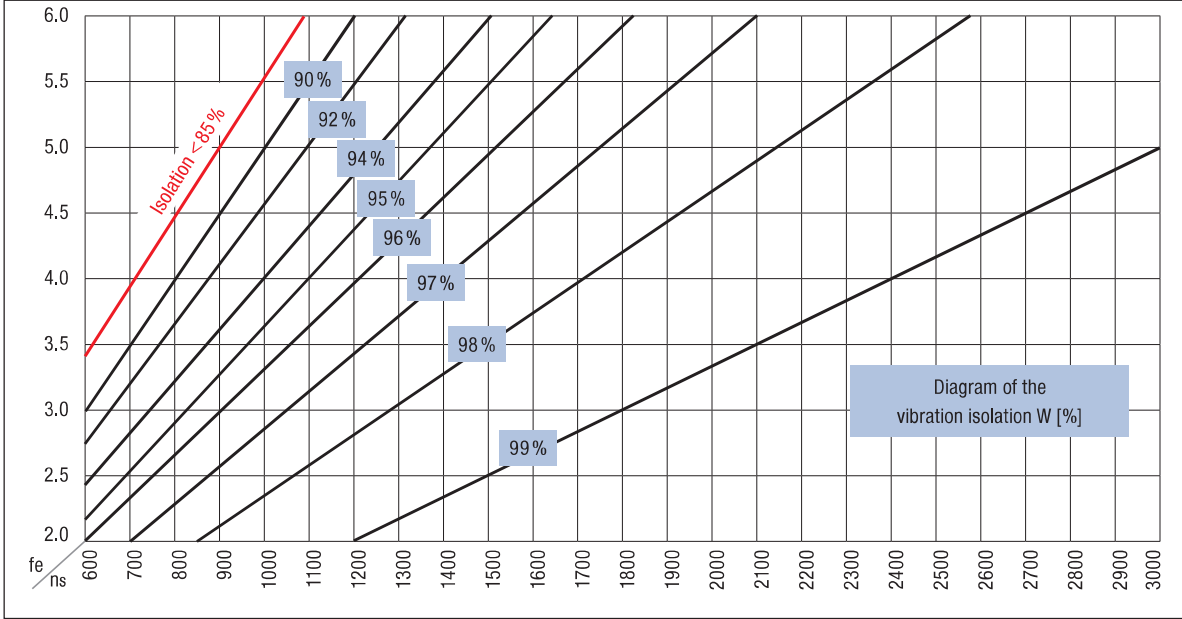

Calculation formula

$$W = 100 - \frac{100}{\left(\frac{n_s}{60 \cdot f_e}\right)^2 - 1} \text{ [%]}$$

Oscillating mountings – free oscillating systems

Average material conveying speed v_m

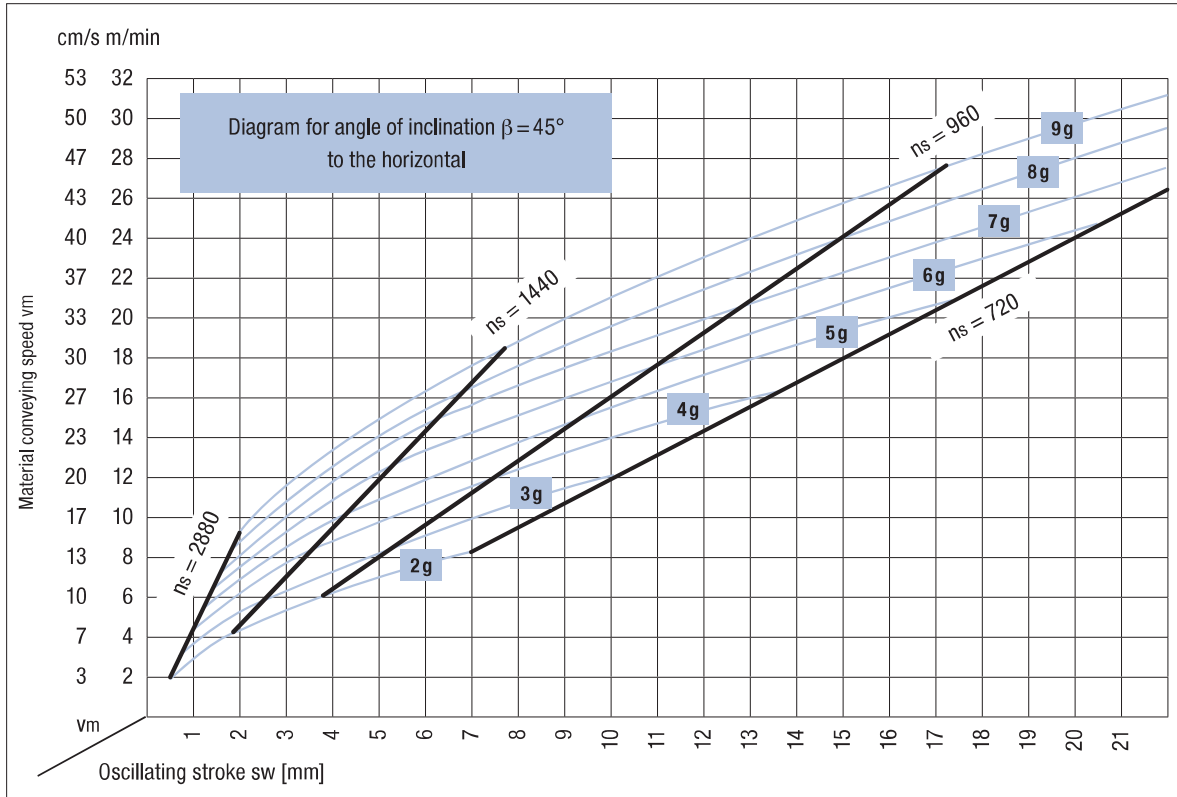

Main influencing factors

- Conveying ability of the material
- Height of the bulk goods
- Inclination of screen base
- Drive angle of the exciters in linear oscillators
- Position of the centre of gravity

The material speed on circular motion screens varies and depends largely on the tilt of the screen box.

Oscillating mountings – free oscillating systems

Operating and resonance behaviour

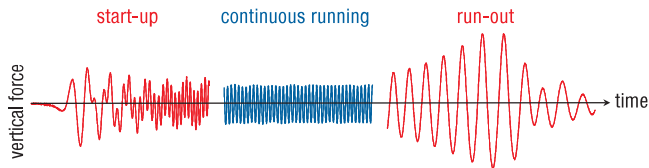

Laboratory measurements of a typical development of the residual forces on a ROSTA screen suspension:

At the screen start-up and run-out, the element's natural frequency is passed through. During the resulting amplitude super-elevation, the four rubber suspension elements generate a high level of damping, which greatly reduces the vibration amplitudes. The screen box therefore stops fully after only a few strokes.

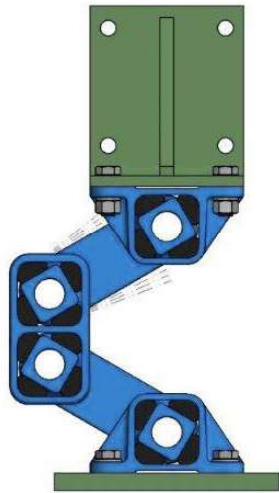

The rocker arm fixed to the screen carries out the greater part of the oscillations. The rocker arm fixed to the substructure remains virtually stationary, provides a strong cushion and ensures a low natural frequency and therefore a good insulation on the base frame.

Alignment of the elements

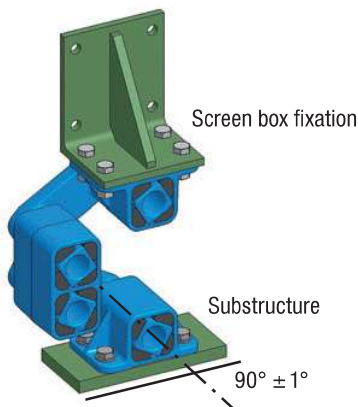

The mounting axis has to be arranged at a right angles (90°) to the conveying axis, with maximum tolerance of $\pm 1^\circ$.

Oscillating mountings – free oscillating systems

Element heights and setting behaviour AB and ABI

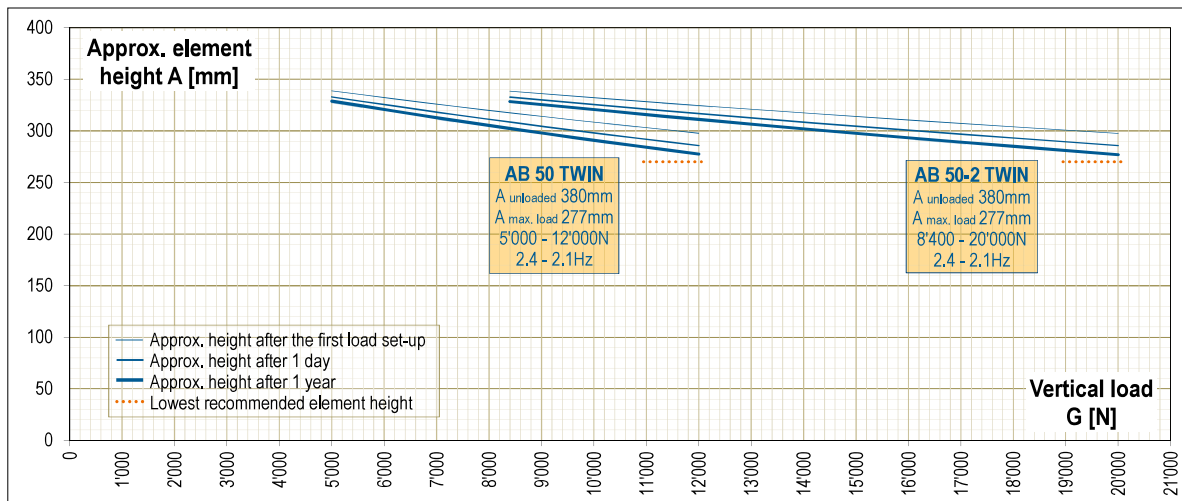
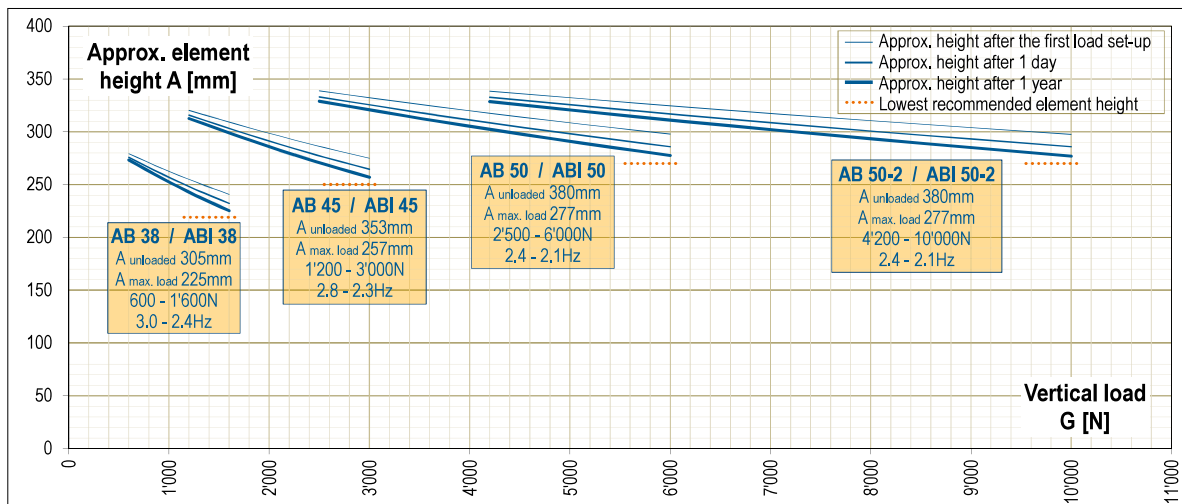
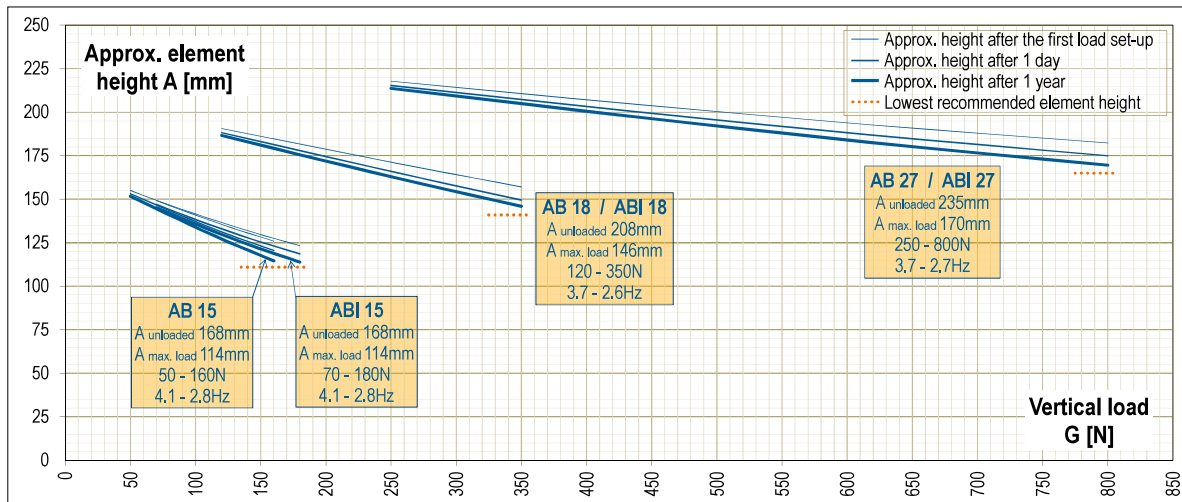

Oscillating mountings – free oscillating systems

Element heights and setting behaviour AB-HD and ABI-HD

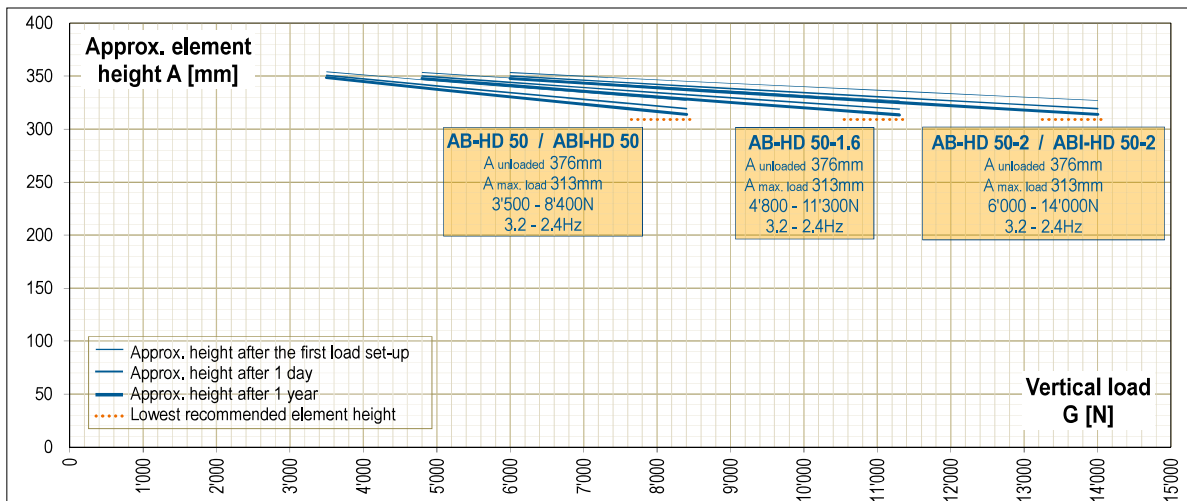
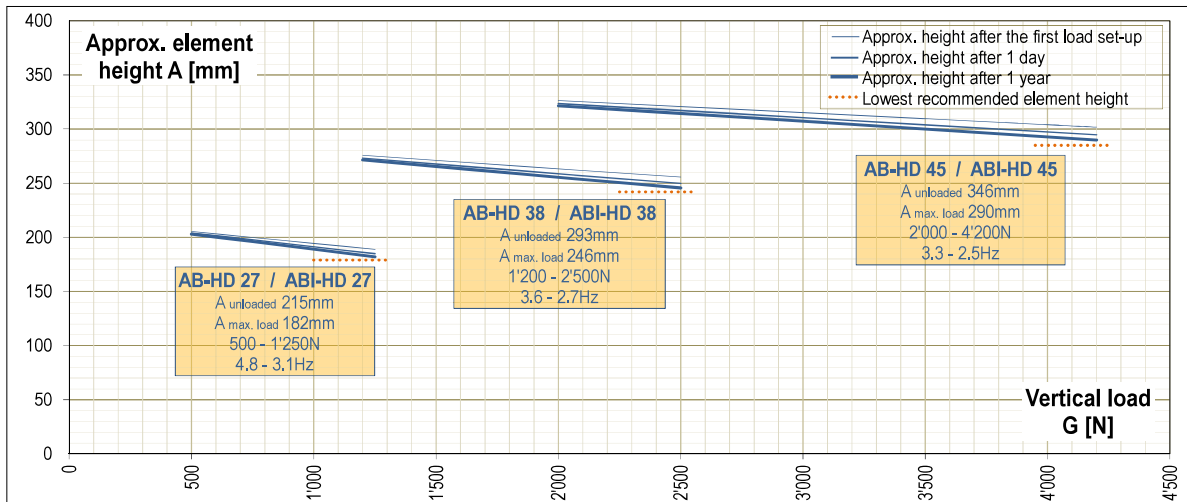
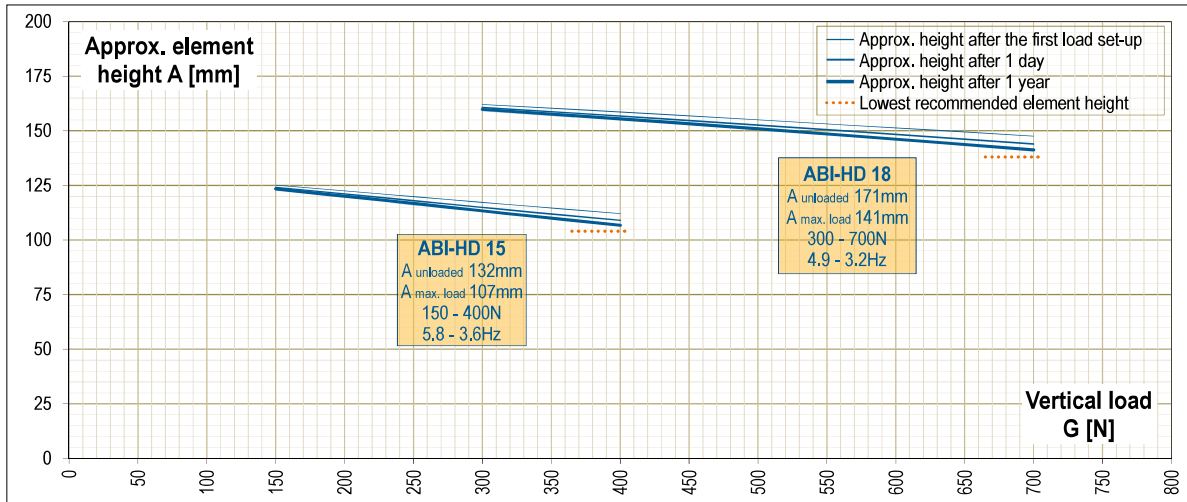

Oscillating mountings – free oscillating systems

Element heights and setting behaviour HS and HSI

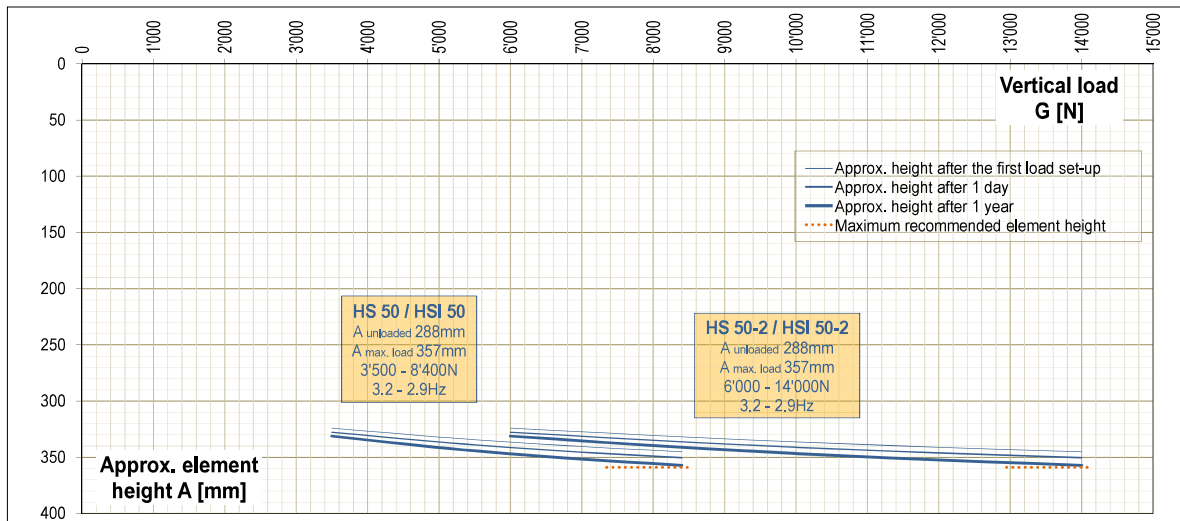
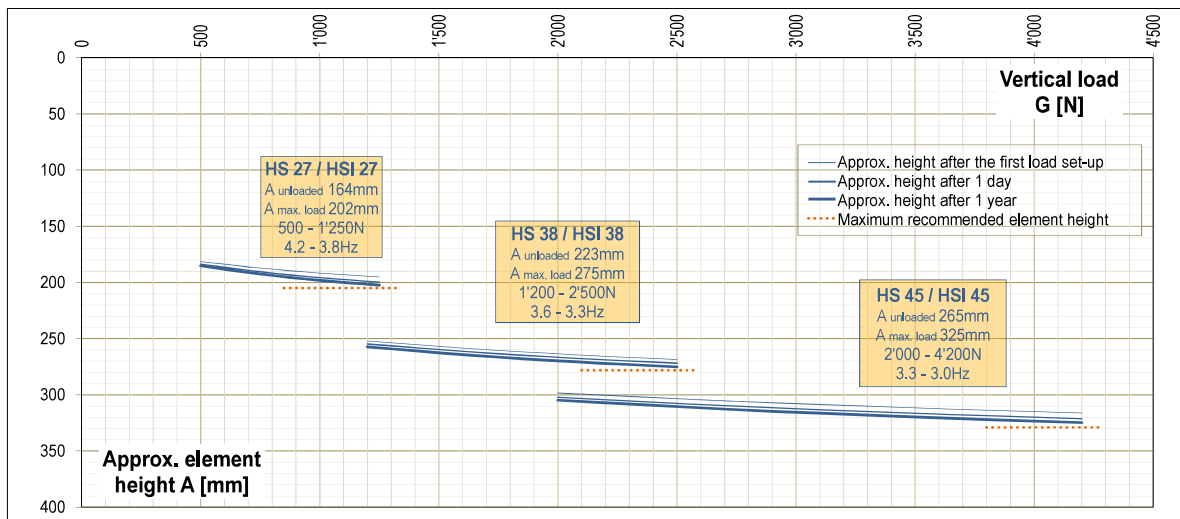
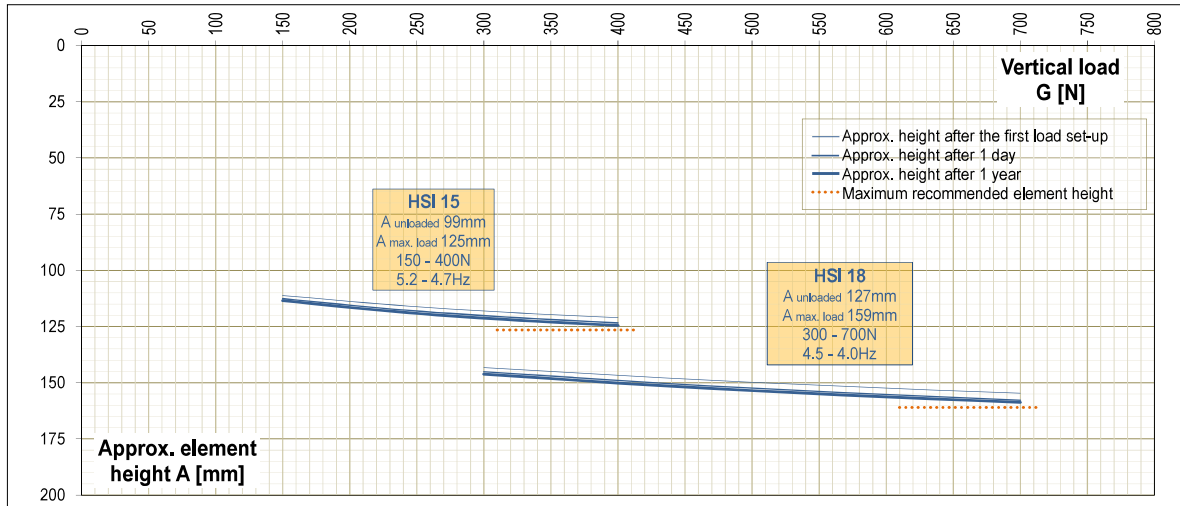

Oscillating mountings – free oscillating systems

Element heights and setting behaviour AB-D

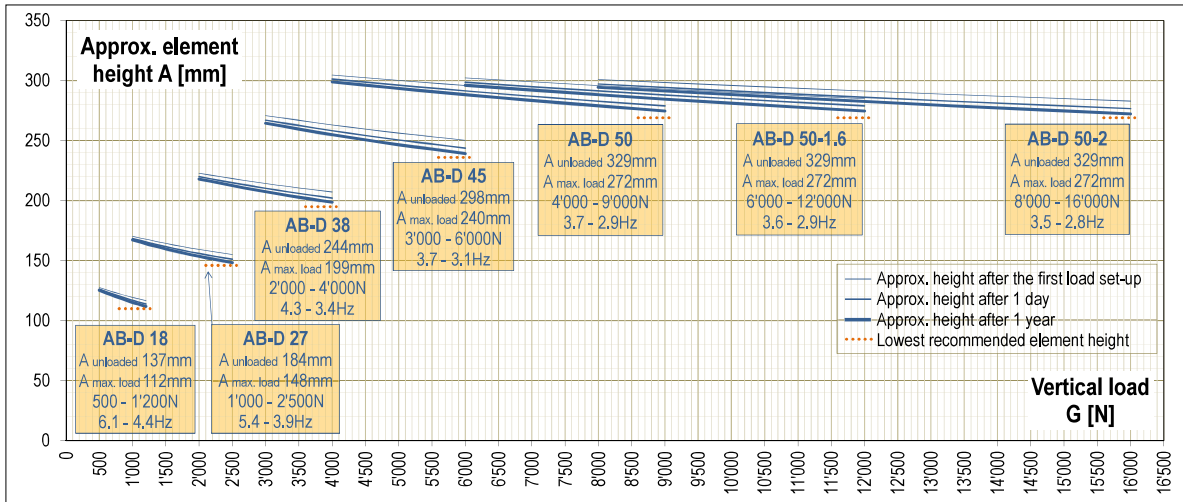

Oscillating mountings – guided systems

One mass systems without spring accumulators: calculation

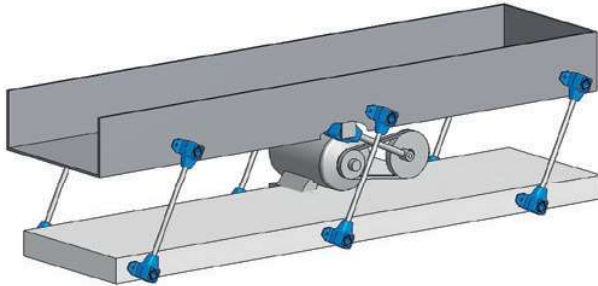

	Subject	Symbol	Unit
Length, weight	Weight empty trough *	m_0	kg
	Weight of feeding material *		kg
	Weight of oscillating mass	$m = m_0 + m_m$	kg
Drive parameter	Eccentric radius	R	mm
	Stroke	$sw = 2 \cdot R$	mm
	Rpm on trough	n_s	min ⁻¹
	Gravity acceleration	g	9.81 m/s ²
	Oscillating machine factor	K	
	Acceleration	$a = K \cdot g$	m/s ²
	Total spring value of system	c_t	N/mm
Rocker arms	Quantity of rockers **	z	
	Load per rocker	G	N
	Center distance of elements	A	mm
Drive	Acceleration force	F	N
	Drive capacity approx.	P	kW
Spring value of natural frequency shaker	Dynamic torque	Md_d	Nm/°
	Dynamic spring value per rocker	c_d	N/mm
	Dynamic spring value of all rockers	$z \cdot c_d$	N/mm
	Resonant ability factor	i	

- * When determining the weight, take into account:
- High coupling factor or sticking of wet and humid material
 - Possible stemming of the trough

** Distance of the rocker max. 1.5 metres.

Calculation formulas

Oscillating machine factor

$$K = \frac{\left(\frac{2\pi}{60} \cdot n_s\right)^2 \cdot R}{g \cdot 1000} = \frac{n_s^2 \cdot R}{894'500} [-]$$

Total spring value of system

$$c_t = m \cdot \left(\frac{2\pi}{60} \cdot n_s\right)^2 \cdot 0.001 \quad [\text{N/mm}]$$

Load per rocker

$$G = \frac{m \cdot g}{z} \quad [\text{N}]$$

Acceleration force (for ST selection)

$$F = m \cdot R \cdot \left(\frac{2\pi}{60} \cdot n_s\right)^2 \cdot 0.001 = c_t \cdot R \quad [\text{N}]$$

Drive capacity approx.

$$P = \frac{F \cdot R \cdot n_s}{9550 \cdot 1000 \cdot \sqrt{2}} \quad [\text{kW}]$$

Dynamic spring value per rocker

$$c_d = \frac{Md_d \cdot 360 \cdot 1000}{A^2 \cdot \pi} \quad [\text{N/mm}]$$

Resonant ability factor

$$i = \frac{z \cdot c_d}{c_t} [-]$$

By a resonant ability factor $i \geq 0,8$ the system is usually titled «natural frequency shaker».

Oscillating mountings – guided systems

One mass system with spring accumulators: calculation

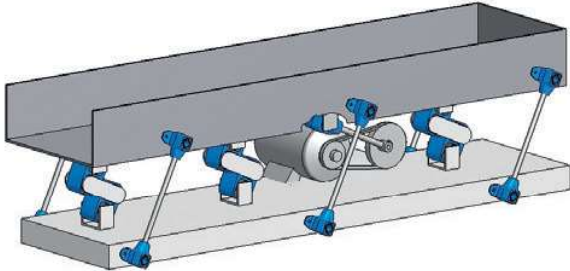

Calculation analog one mass systems without spring accumulators with following additions:

Subject	Symbol	Unit	Calculation formulas
Spring accumulators	Quantity	Z_s	$i_s = \frac{Z \cdot C_d + Z_s \cdot C_s}{C_t} [-]$
	Dynamic spring value per item	C_s	
	Dynamic spring value of all items	$Z_s \cdot C_s$	By a resonant ability factor is ≥ 0.8 the system is usually titled «natural frequency shaker».
	Resonant ability factor	i_s	

One mass conveyor system: installation instructions

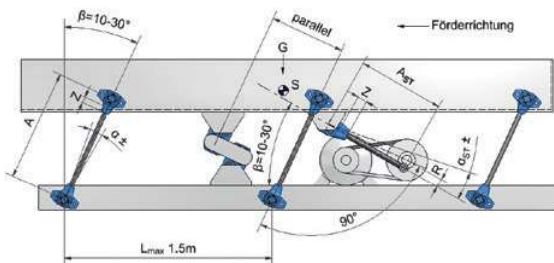

Distance between rockers L_{max} :

- Usually, the distance between the rockers in the longitudinal direction must not exceed 1.5 metres.
- With chutes wider than 1.5m, we recommend fitting a third row or multiple rows of rockers on the underside of the chute base or to install spring accumulators to improve the stability.

Mounting position drive head ST:

For one mass shaker systems it is recommendable to position the drive head slightly ahead of the center of gravity of the trough, towards the discharge end.

Angle of attack β :

The angle of attack β of the rocker must be between 10° and 30° to the perpendicular line, depending on the process and the conveying speed. (The optimum combination of a fast conveying speed and the high material throw is given at the angle of attack $\beta = 30^\circ$.) The operating direction of the drive rod should be at 90° , i.e. the thrust angle of attack β is accordingly between 10° and 30° to the horizontal line.

Oscillation angle α :

The parameters for the oscillation angle and speed must be within the permissible range, see «permissible frequencies» in chapter 7 Technology.

Screw grade:

Select screw grade 8.8 and mount with correct tightening torque.

Thread length Z:

The thread length Z is at least $1.5 \times$ the nominal thread size.

Oscillating mountings – guided systems

Two mass system with direct mass balance

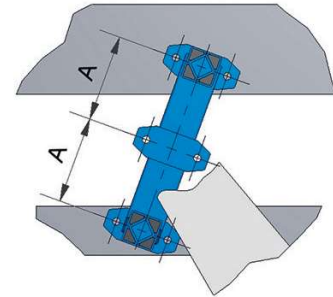
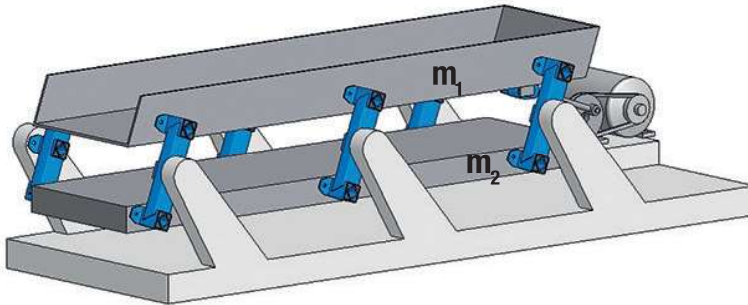

- Max. acceleration of approx. 5 g and max. chute length of approx. 25 metres
- Double rockers made from ROSTA elements AR, AD-P or AD-C
- Optimal balance of forces with $m_1 = m_2$
- Calculation same as for one mass system, with the following difference:

Actuated mass incl. material coupling	m_1 [kg]
Driven mass incl. material coupling	m_2 [kg]
Total oscillating mass	$m = m_1 + m_2$ [kg]

Dynamic spring value per rocker
[N/mm]

$$c_d = \frac{3 \cdot M d_s \cdot 360 \cdot 1000}{2 \cdot A^2 \cdot \pi} \quad [\text{N/mm}]$$

- Calculation of c_i and F with the new total oscillating mass m
- Introduction of force with the ST at any point along the chute, 90° to the rocker axis
- For customised rockers with different centre distances A , please contact ROSTA

Oscillating mountings – guided systems

Average material conveying speed v_m

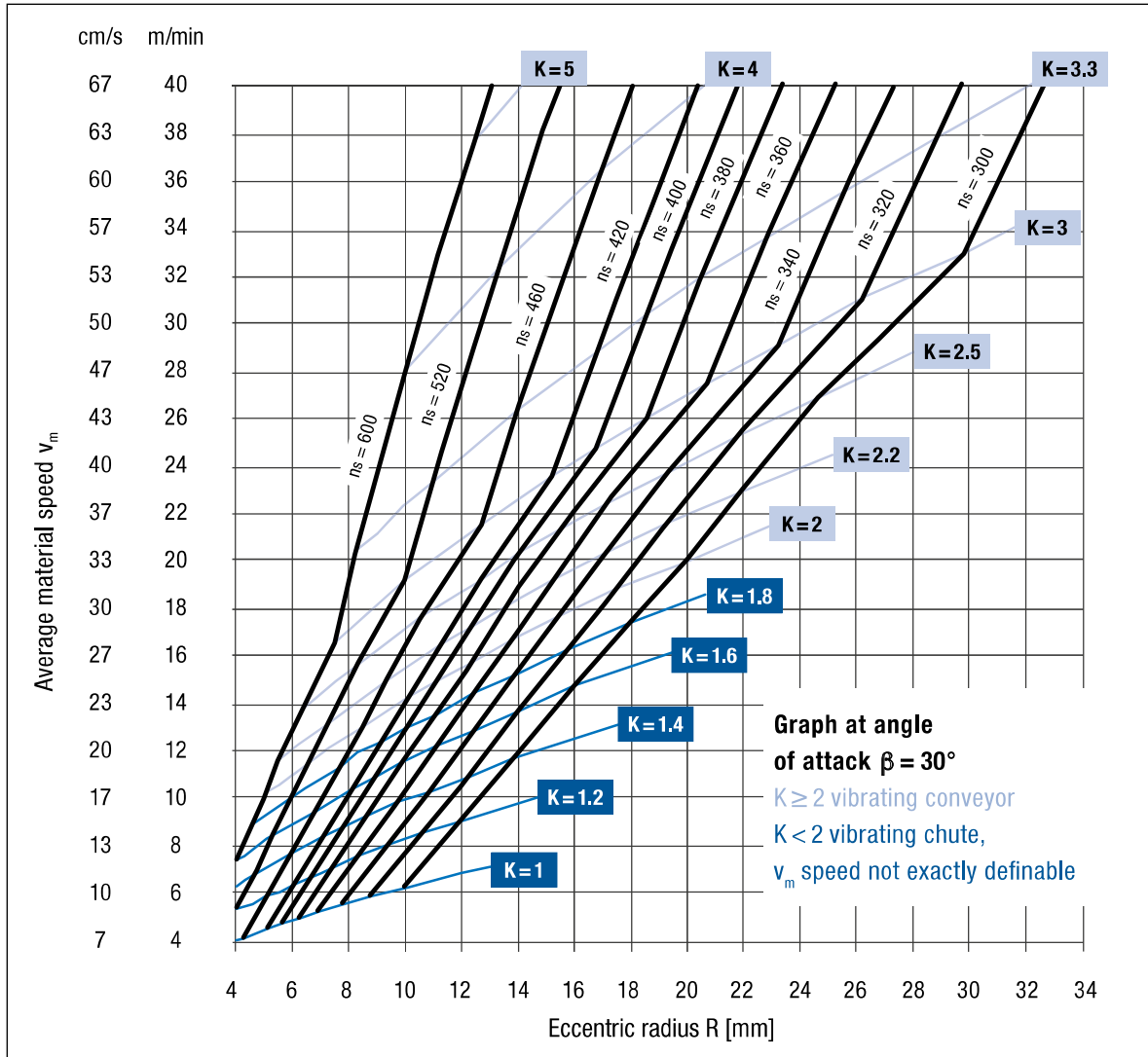

Main influence factors:

- bulk height
- sieve surface texture
- drive angle and thus rocker angle of attack
- feeding capacity is dependent on shape and humidity of the material, e.g. dry, fine-grained material needs correction factors up to 30%.

By acceleration factors $K > 2$ and rocker mounting angles of $\beta = 30^\circ$ (to the perpendicular line) the vertical acceleration is getting bigger than 1g, therefore the material starts lifting from the trough bottom = material throw.

Oscillating mountings – guided systems

Maximum load G , speed n_s and oscillation angle α

Size (e.g. AU 15)	max. load capacity per rocker [N]				max. revolutions n_s [min^{-1}] *	
	K<2	K=2	K=3	K=4	$\alpha \pm 5^\circ$	$\alpha \pm 6^\circ$
15	100	75	60	50	640	480
18	200	150	120	100	600	450
27	400	300	240	200	560	420
38	800	600	500	400	530	390
45	1600	1200	1000	800	500	360
50	2500	1800	1500	1200	470	340
60	5000	3600	3000	2400	440	320

Please contact ROSTA for higher machine parameters and elements with greater loads.
The revolutions are usually $n_s = 300$ to 600 min^{-1} and oscillation angle α to max. $\pm 6^\circ$.
* see «permissible frequencies» in chapter 7 Technology.

The oscillation angle α of each component must be within the permissible range of application (n_s and α), i.e. rockers, drive rods and spring accumulator.

Calculating the oscillation angle for rockers

Eccentric radius R [mm]

Center distance A [mm]

Oscillation angle $\alpha \pm [^\circ]$

$$\alpha = \arctan\left(\frac{R}{A}\right) [^\circ]$$

AU/AUI: Connection rod

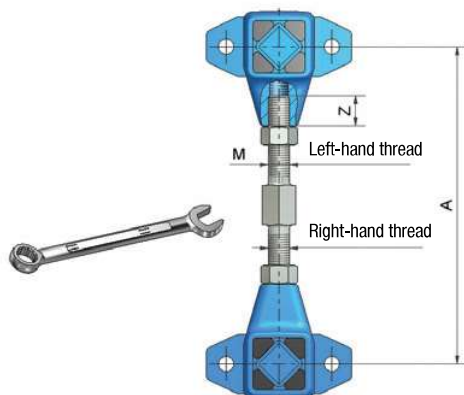

The customer manufactures the connection rod, preferably with a left and right-hand thread. Together with the corresponding oscillating mountings, the distance between the mountings (A) can be freely adjusted. Using a standard threaded rod (with «only» a right-hand thread) may be more economical, but it is less accurate.

The centre distance A must be set identically for all rockers and the thread length Z must be at least $1.5 \times M$.

AS/AD: Resulting oscillation angle α from eccentric radius R

Single rocker AS

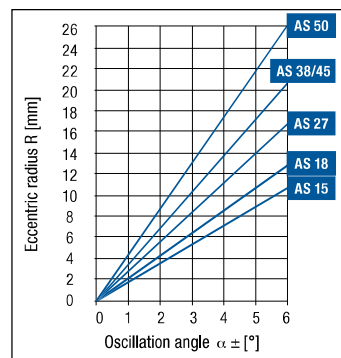

Double rocker AD

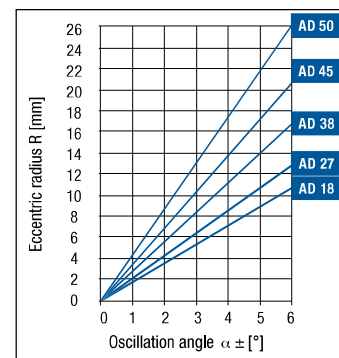

Oscillating mountings – guided systems

AR: Single, double and two-way Rocker

Single rocker

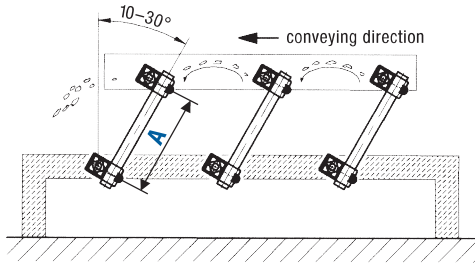

The two AR elements are pushed onto a round tube. The desired center distance is set on a straightening plate and then fixed by tightening the clamp.

Double rocker

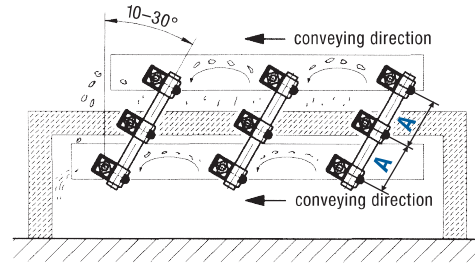

With three AR elements, the tube wall thickness is adjusted to the centre distances A, see «dimensioning of the connecting tubes». The counterweight can be used as an additional conveyor trough with the same conveying direction.

Two-way rocker

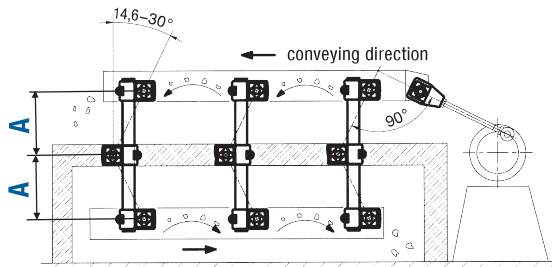

The three AR elements mounted in the boomerang configuration create a two-way material flow. Tube wall thickness according to «dimensioning of the connecting tubes». This two-way conveying flow can simplify the conveying process and the mass balance is maintained with this arrangement.

AR: Dimensioning of the connecting tubes

For double rockers and two-way rocker

Type	Tube- \emptyset	thickness of tube	max. centre distance A	resulting min. angle of attack β [°] with two-way rocker
AR 27	30	3	160	26.0
		4	220	19.5
		5	300	14.6
AR 38	40	3	200	27.5
		4	250	22.6
		5	300	19.1
AR 45	50	5	300	23.4
		8	400	18.0

The customer provides the connecting tubes.

For single rockers with AR 27 or AR 38, it is sufficient for the tubes to have a wall thickness of 3 mm up to A = 300 mm.

For different centre distances A, please contact ROSTA.

Oscillating mountings – guided systems

ST/STI: Length of drive rod A_{ST} and eccentric radius R

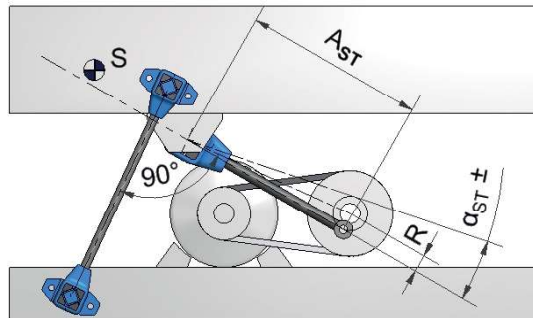

To introduce the force in balance, the deflection angle α_{ST} of the drive rod must not exceed $\pm 5.7^\circ$. This corresponds to a ratio $R:A_{ST}$ of 1:10.

Calculation deflection angle

Eccentric radius R [mm]

Center distance A_{ST} [mm]

Deflection angle $\alpha_{ST} \pm [^\circ]$

$$\alpha_{ST} = \arcsin \left(\frac{R}{A_{ST}} \right) [^\circ]$$

DO-A: Operating parameters and installation guidelines

Example deflection angle DO-A (series connection)	Accumulator cons. of 2 x DO-A 45				Accumulator cons. of 2 x DO-A 50			
	R	sw	max. n_s	max. K	R	sw	max. n_s	max. K
$\pm 6^\circ$	15.3	30.6	360	2.2	16.4	32.8	340	2.1
$\pm 5^\circ$	12.8	25.6	500	3.6	13.6	27.2	470	3.4
$\pm 4^\circ$	10.2	20.4	740	6.2	10.9	21.8	700	6

The connecting levers made by the customer, between the DO-A elements, are at 90° to the DO-A element axis. A cross bracing can be installed (V) if required. The DO-A elements are parallel to each other and parallel to the rockers; they are attached by means of a fork construction at a rigid point on the vibrating conveyor and base frame.

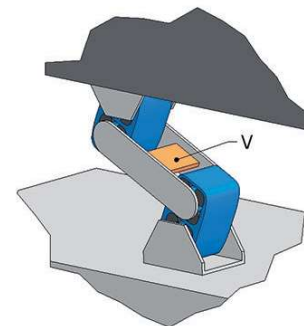
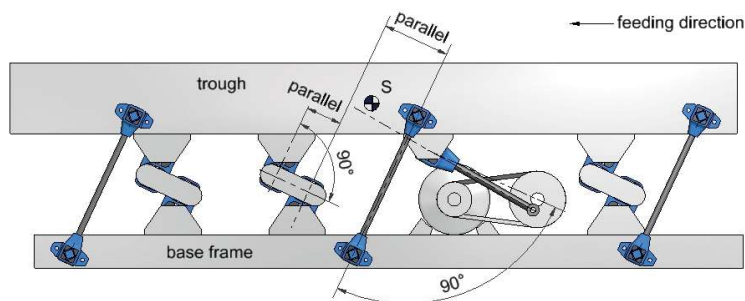

Oscillating mountings – gyratory sifters

AK: Installation guidelines for gyratory sifters

1. Arrange the two inner elements offset by 90° (even torsional load).
2. Connect the AK, adjust the installation height. Even when the sifters are at an angle, the column height «X» must be identical.
3. Angle supports type WS can be used up to AK 50 (see chapter 2 rubber suspension elements).
4. To avoid unwanted tilting and turning, the screen box's centre of gravity «S» is positioned on or within the universal joint column.

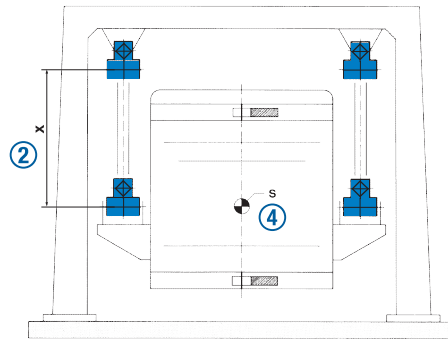
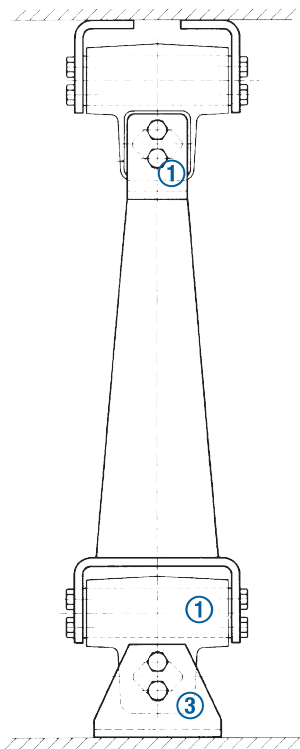

Hanging and freely oscillating gyratory sifter

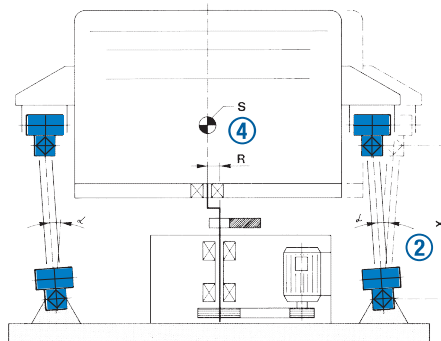

Standing gyratory sifter with positive crank shaft drive

AK: Calculation for gyratory sifters

Machine type: standing gyratory sifter with positive crank drive

Description	Symbol	Unit	Calculation formula
Total oscillating mass (material included)	m	kg	Oscillation angle $\alpha = \arctan\left(\frac{R}{X}\right) [^\circ]$
Eccentric radius	R	mm	
Length of support column	X	mm	
Oscillation angle (out of R and X)	$\alpha \pm$	°	Load per column $G = \frac{m \cdot g}{z} [N]$
Quantity of support columns	z	pcs.	
Load per column	G	N	

Limitation of application parameters see «permissible frequencies» in chapter 7 Technology.

Oscillating mountings – gyratory sifters

AV: Installation guidelines for gyratory sifters

1. With the right-hand and left-hand threaded versions, the length X of the suspension rod can easily be adjusted. X has to be identical for all columns and the specified angle limitations must be respected!
2. Installing the two elements in a crosswise configuration moves the gyratory sifter in a circular motion.
3. Installing the two elements in the same configuration moves the gyratory sifter in an elliptical motion.
4. To avoid unwanted tilting or turning, the centre of gravity of the screen box «S» is positioned at the same level or slightly below the suspension rod's attachment.
5. Please consult ROSTA in the selection of AV elements for standing gyratory sifters.

② circular oscillation

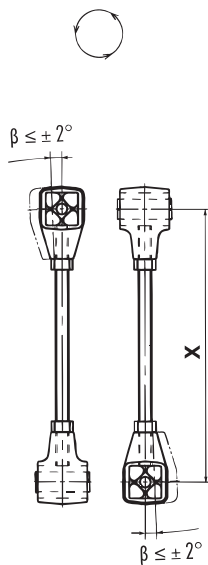

③ elliptical oscillation

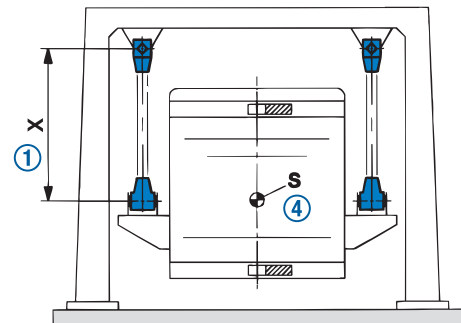
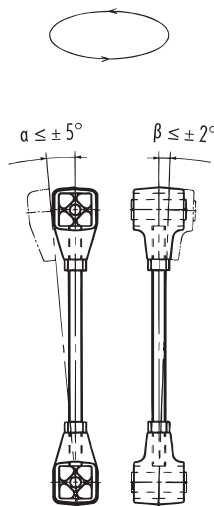

AV: Calculation for gyratory sifters

Description	Symbol	Unit	Calculation formula
Total oscillating mass (material included)	m	kg	Oscillation angle $\beta = \arctan\left(\frac{R}{X}\right) [^\circ]$
Eccentric radius ②	R	mm	
Length of suspension rod	X	mm	
Oscillation angle (out of R and X), shall not exceed $\pm 2^\circ$ ②	$\beta \pm$	°	Load per suspension rod $G = \frac{m \cdot g}{z} [N]$
Quantity of suspension rods	z	pcs.	
Load per suspension rod	G	N	

Limitation of application parameters see «permissible frequencies» in chapter 7 Technology.